



City & County of
San Francisco



Shared Spaces Manual

VERSION 2.3

December 2022



Mayor

London N. Breed

Board of Supervisors

Connie Chan (District 1)
Catherine Stefani (District 2)
Aaron Peskin (District 3)
Gordon Mar (District 4)
Dean Preston (District 5)
Matt Dorsey (District 6)
Myrna Melgar (District 7)
Rafael Mandelman (District 8)
Hillary Ronen (District 9)
Shamann Walton, *Board President* (District 10)
Ahsha Safai (District 11)

City Departments

Rich Hillis, Director, *San Francisco Planning*
Carla Short, Interim Director, *San Francisco Public Works*
Jeffrey Tumlin, Director, *San Francisco Municipal Transportation Agency*
Maggie Weiland, Director, *San Francisco Entertainment Commission*
Nicole Bohn, Director, *Mayor's Office on Disability*
Cyd Harrell, Director, *Digital Services*
Kate Sofis, Director, *Mayor's Office of Economic and Workforce Development*
Chief Jeanine Nicholson, Director, *San Francisco Fire Department*
Katy Tang, Director, *Office of Small Business*

Shared Spaces Program Interagency Staff

SAN FRANCISCO PLANNING

Robin Abad, *Program Director*
Annie Yalon, *Deputy Program Manager*
Gary Chen
María De Alva
Oscar Hernandez-Gomez
Matthew Thompson

SAN FRANCISCO MUNICIPAL TRANSPORTATION AGENCY

Monica Munowitch, *Deputy Program
Manager*
Nick Chapman
Mari Hunter
Francesca Napolitan
Parin Patel

SAN FRANCISCO PUBLIC WORKS

Gregory Slocum, *Permits Manager*
Michael Lennon, *Manager, Inspection
and Enforcement*
Kelly Albers
Kevin Jensen
Fady Khoury
Karina Lairet
Debra Lutske
Nicholas Persky
Jessica Salamy
Iyabo Williams

SAN FRANCISCO DIGITAL SERVICES

Bekah Otto
Jim Brodbeck

SAN FRANCISCO ENTERTAINMENT COMMISSION

Kaitlyn Azevedo
Dylan Rice

SAN FRANCISCO FIRE DEPARTMENT

Fire Marshal Ken Cofflin
Asst. Fire Marshal Chad Law
Olivia Scanlon
Lieutenant Dennis Sy

MAYOR'S OFFICE ON DISABILITY

John Romaidis

MAYOR'S OFFICE OF ECONOMIC AND WORKFORCE DEVELOPMENT

Ben Van Houten
Kerry Birnbach

311 CUSTOMER SERVICE CENTER

Carson Chinn
Bryan Wong

DEPARTMENT OF TECHNOLOGY

Jeff Johnson

SAN FRANCISCO PUBLIC UTILITIES COMMISSION

John Scarpulla

Shared Spaces Manual

WEBSITE:
sf.gov/sharedspaces



EMAIL:
sharedspaces@sfgov.org



SOCIAL MEDIA:
[@sharedspacesSF](https://www.instagram.com/sharedspacesSF)



ABOUT THIS MANUAL

The San Francisco Shared Spaces Manual is a comprehensive overview of the goals, policies, procedures, and guidelines for the Shared Spaces program in San Francisco. These guidelines shall not be construed as authorizing or approving any improvements or uses of the public right-of-way that are inconsistent with applicable Federal, State, and Local statutes and regulations.

Applicants, designers, and contractors are strongly encouraged to read the Shared Spaces Manual in its entirety when they are first thinking about participating in the program, and to refer to it often throughout the process.

San Francisco values and appreciates your willingness to devote your time, creativity, and resources to implementing this program in your neighborhood. We look forward to collaborating with you!

The following documents are referenced in this Manual. Please refer to these for further details on design guidelines and operations for the Shared Spaces Program.

- [San Francisco Public Works Code, Section 793](#)
- [Public Works Regulations for Shared Spaces](#)
- [SFMTA Regulations for Shared Spaces](#)
- [San Francisco Fire Code](#)

① 311 Free language assistance / 免費語言協助 / Ayuda gratis con el idioma / Бесплатная помощь переводчиков / Trợ giúp Thông dịch Miễn phí / Assistance linguistique gratuite / 無料の言語支援 / 무료 언어 지원 / Libreng tulong para sa wikang Filipino / การช่วยเหลือทางด้านภาษาโดยไม่เสียค่าใช้จ่าย / ٣١١ خدمة مجانية للمساعدة في اللغة / ٣١١ خدمة مجانية للمساعدة في اللغة

A NOTE ABOUT ELECTRONIC AND DIGITAL ACCESSIBILITY:

This manual contains detailed architectural design drawings, photographs and instruction that is largely visual in nature. If you need assistance accessing the manual, please contact the Shared Spaces team at sharedspaces@sfgov.org

Table of Contents

1. Overview	01
Program Goals	03
Transitioning from pandemic to legislated program	04
Types of Shared Spaces	05
Shared Spaces Uses	06
2. Design Guidelines and Regulations	07
Important Considerations	08
Sidewalk Shared Spaces	10
Parking or Curbside Lane Shared Spaces	15
Location and Site Treatments	17
Fire Safety and Emergency Access	33
Accessibility	49
Roadway Shared Spaces	55
Private Lot Shared Spaces	59
Outdoor Entertainment and Amplified Sound	61
3. Shared Spaces Operations	63
Operator's Responsibilities	64
4. Enforcement	67
Compliance Timeline	72

5. Appendices	75
Applying for a Shared Spaces Permit	77
Application Checklist	79
Curbside or Parking Lane Site Plan Template	87
Neighboring Occupancy	89
Neighbor Letter of Consent	91
Neighborhood Outreach Samples (Optional)	93
Certificate of Insurance Sample	97
Shared Spaces Design Guidelines and Regulations	99
Accessibility Supplement	112
Public Health	115

A photograph of two children riding balance bikes in an outdoor public space. The child on the left is wearing a helmet with a skull design and a light-colored t-shirt. The child on the right is wearing a dark helmet and a t-shirt with a San Francisco logo. In the background, a person wearing a face mask is walking, and there are buildings and a sign that says "JUICE SHOP".

SECTION 1

Overview

Photo by Shared Spaces.

The Shared Spaces program allows San Francisco residents, community and non-profit organizations; small business owners; and art, entertainment, and cultural organizations to activate the public realm for community-focused purposes and commerce.

Streets and sidewalks make up about twenty-five percent of the City's land area and are an integral part of our daily experience. Many roadways were widened during the mid-twentieth century to create more space for automobiles. As we have moved away from having a single mode of transportation dominating cities across the world, San Francisco has responded by creating programs to help residents transform the public right-of-way to accommodate the different needs of all users of the public realm.

By exploring the potential of our city's streets and sidewalks, the Shared Spaces program seeks to balance the needs of people using the public realm to travel by different modes, provide pedestrian amenities, support local businesses, and foster neighborhood interactions.

The Shared Spaces program builds upon the Places for People legislation, adopted in 2016, and the lessons learned from the temporary emergency program established during the COVID-19 pandemic.



Photo by Shared Spaces.

Program Goals



1. Simplify the City's Toolbox

Simplify the City's toolbox by consolidating the permit process, streamlining it for permittees and creating a single, one-stop permit portal.



2. Prioritize Equity & Inclusion

Prioritize equity and inclusion by prioritizing City resources for communities most impacted by historical disparities with funding, materials and grants. Ensure that shared spaces are accessible to persons with a disability.



3. Phase Implementation with Economic Conditions

Phase the implementation of the program with economic conditions so that businesses have time to adapt to the new permit process.



4. Encourage Arts, Culture, & Entertainment

Encourage arts, culture and entertainment activities in a wide variety of public spaces.



5. Balance Curbside Functions

Balance the needs of the curb by ensuring our Transit First and Vision Zero policies remain priorities. Balance Shared Spaces occupancies with loading, short-term parking, micro mobility needs, and other curbside functions; and encourage sharing of Shared Spaces amongst merchants on the same block.



6. Maintain Public Access

Maintain public access by ensuring every Shared Space provides public access when not in commercial use and providing a seating opportunity during daytime hours, including business, operating hours.



7. Efficient Permit Review & Approval

Efficient Permit Review and Approvals with a clearly defined timetable. This allows for better design quality and therefore safety.



8. Clear Public Input Procedures

Clear Public Input Procedures will encourage collaboration between neighbors and merchants.



9. Coordinated Enforcement

Coordinated Enforcement by a single agency with a 'Single Bill of Health,' which is easy for operators to understand and comply with.

Transitioning from pandemic to legislated program

On Tuesday July 20, 2021, the San Francisco Board of Supervisors unanimously passed [the Shared Spaces Ordinance](#).

Legislated rules for Shared Spaces will go into effect gradually over the next year.

Pandemic Permits Extended

On March 22, 2022, the Board of Supervisors passed the [Shared Spaces Permit Extension Legislation](#).

Pandemic Permits for sidewalk tables & chairs, sidewalk merchandizing, parklets, and private lots are set to expire on March 31, 2023.

Roadway (Temporary Street Closure) Permits do not automatically extend. To operate a Roadway Temporary Street Closure on or after April 1, 2023, you will need a new legislated permit.

All legislated permit applications are due on January 15, 2023.



Due January 15, 2023

Permit application deadline for legislated permits

August 28, 2021

September 2021

Fall 2021

March 31, 2022

April 1, 2023

ADA access, emergency response, and transit rules start.

Applications open for legislated Shared Spaces permits.

We are contacting businesses that need to change their parklets.

Some parklets near intersections may need to change.

Pandemic Shared Spaces Program ends and the legislated Shared Spaces Program begins

See detailed compliance timeline on [Section 4: Enforcement](#), or go to sf.gov/sharedspaces for the latest information.

Definitions:

- Pandemic Shared Spaces Program: Emergency pandemic program with temporary permits with relaxed provisions. Ends 3/31/2023.
- Legislated Shared Spaces Program: Passed on 7/20/2021, formal program with regulations which will gradually go into effect through 4/1/2023.

Types of Shared Spaces

Sidewalk

- Sidewalk Café Tables and Chairs, similar to the pre-existing sidewalk dining permit, but with more streamlined public notice requirements
- Non-commercial use of the sidewalk, for example publicly accessible seating facilities or other fixtures.
- Sidewalk merchandising, displaying goods outside



Parking Lane

- A Public Parklet, similar to the City's pre-COVID parklets, a fixed structure providing full-time, publicly accessible space and no commercial activity.
- A Movable Commercial Parklet, a space occupied by the operator using movable elements during limited business hours with a bench or other public seating facility. This option allows operators to use curb space that is needed for other curbside functions during the day, such as a brunch restaurant that only operates until 1pm, after which the curb space is used for loading or short-term parking.
- A Commercial Parklet, similar to existing Shared Spaces, a fixed structure where an operator uses the parklet for commercial activity during business hours with a bench or other public seating facility, and is otherwise open to the public during non-commercial daytime hours.



Roadway

- Activation of space normally used for traffic for a community and commercial uses, free and open to the public. For the first two years of a roadway closure, most events will be approved through the existing ISCOTT process, which includes membership of key departments, including SFMTA, SFPD, SFFD, Public Works.



Private Property

- Rear yards, vacant lots, parking lots, patios



Shared Spaces Uses

The Shared Spaces program allows for the use of sidewalk, parking lane, roadway, and/or private property for different activities, including but not limited to:

- Outdoor seating and dining
- Personal services
- Merchandise display
- Entertainment, art, performances
- Not-for-profit or other community-serving activities or events



Photo by Shared Spaces.



Photo by Shared Spaces.



Photo by Shared Spaces.



Photo by Entertainment Commission.



Photo by SF Examiner

Outdoor Entertainment and Amplified Sound

- This includes live music and other performing arts happening on a recurring basis or at one time at all types of outdoor Shared Spaces locations.



Photo by Shared Spaces.



Photo by Britt Govea

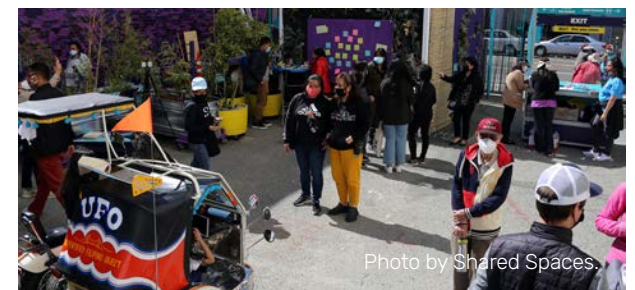

Photo by Shared Spaces.

A photograph of a public space, possibly a park or plaza, with a purple tint. In the center, a group of people, including a woman in a patterned dress and a man in a jacket, are gathered around a small, decorated vehicle. The vehicle has text on it, including "VEBODYMAN", "por wan pibe", and "TNT". To the right, a motorcycle is parked with "HOY!" written on its front. In the background, there are buildings and a decorative structure with intricate patterns. A child is sitting on a bench on the right side of the image.

SECTION 2

Design Guidelines and Regulations

Photo by SF Planning.

Important Considerations

To ensure the safety of all people using the public right-of-way, including Shared Spaces users, you will need to follow a series of guidelines and regulations when implementing your Shared Space. These are some of the best practices for any type of Shared Spaces:

Location and Site Treatments



Shared Spaces should consider existing city infrastructure and street design when planning for placement. Your Shared Spaces must not obstruct pedestrian visibility, crosswalks, bicycle lanes, traffic signals or other traffic warning devices, and must allow proper stormwater drainage flow and streetscape maintenance.

Fire Safety and Emergency Access



Emergency responders utilize the most direct path to access a building from the street to assist citizens in need of medical attention or for firefighting operations. You must provide enough clearance for responders to maneuver and operate through and around your Shared Spaces. Obstructing emergency access at any time may lead to immediate danger to health or life safety.

Accessibility



Shared Spaces thrives to be fully accessible to, and useable by, all people with disabilities. All accessibility elements of the proposed structure shall be designed, constructed and/or conform to the applicable provisions, rules, regulations and guidelines of the San Francisco Building Code (SFBC) and Americans with Disabilities Act 2010 Standards accessibility requirements (ADAAG).

How to read these Guidelines

This updated version of the Shared Spaces Manual seeks to better communicate guidelines and regulations through real examples of safe and unsafe conditions. The regulations are called out throughout the document, and in the Appendices section as follows:

Symbology:

- Sidewalk Regulations S1
- Parking or Curbside Lane Regulations P1
- Roadway Regulations R1
- Location & Site Treatments
- Fire & Emergency Access
- Accessibility
- Traffic Safety

Title/Topic

Performance criteria

Image example with graphic dimensions or call-outs to illustrate performance criteria

Image caption explains how an image exemplifies safe or unsafe conditions

Location and Site Treatments 📍

Visibility at Intersections

Your Shared Spaces must not obstruct pedestrian visibility, crosswalks, bicycle lanes, traffic signals or other traffic warning devices.



✗ Structure's proximity to the intersection obstructs visibility and endangers pedestrians.

P76 The enclosure should not block the view of traffic, including pedestrian traffic, nor block the view of traffic control devices such as traffic signs, traffic signals, and other traffic warning devices. It should not obstruct motorists' visibility of traffic signals from 200 feet away (about half a block).



✗ Structure's proximity to the intersection blocks traffic signs

Page 9 Shared Spaces Manual | December 2022 | Design Guidelines and Regulations

Category

Reference to Guidelines & Regulations or additional information

Image example

Image caption

Safe Condition ✔ Unsafe Condition ✗

S Sidewalk Shared Spaces





Site Design Diagram for Sidewalk Shared Space

- A** Sidewalk diverters at 90 degrees flush with building, at each end of Shared Space. Minimum Dimensions: 30 inches high, 12 inches wide, 24 inches long
- B** Minimum 8-foot wide unimpeded path for pedestrians (where feasible)
- C** 4-foot clearance surrounding area beneath fire escape ladders
- D** Sidewalk Shared Spaces may not occupy the space adjacent to the curb, regardless of curb color. Exceptional circumstances may be considered if a hardship is present
- E** 5-foot clearance around a fire hydrant
- F** Provide at least one 30-inches x 48-inches clear space for wheelchair users at accessible tables. If a counter is provided, the accessible counter portion shall be 60" minimum in length.
- G** 3-foot clearance around Fire Department connections on buildings
- H** Bus stop zones must be maintained clear of furniture and structures. No furniture shall be placed within 10 feet of a bus shelter structure
- I** Curb return and all curb ramps shall not be obstructed by Shared Space elements.



Where can I place my Sidewalk Shared Space?

You may occupy the sidewalk space fronting your business, organization, or residence to display merchandise, place tables and chairs, public seating, or other amenities. Amenities other than tables and chairs or display merchandise will be reviewed on a case-by-case basis.

You will need your neighbor's permission if you want to occupy their frontage as well.

- Check the diagrams in this section to ensure your proposed space is feasible.
- Diverters, furnishings and fixtures for commercial purposes must be removed at the end of business hours.
- Sidewalk Shared Spaces may only be placed on the sidewalk area adjacent to the building, at the property line. Proposals for different placement will be reviewed on a case-by-case basis.
- You must get your neighbor's permission to use any of the sidewalk in front of them. See sample on *Section 5: Appendices*.

FIRE SAFETY & EMERGENCY ACCESS



- S1 Emergency Access.** At no time can sidewalk occupancy obstruct emergency facilities (including, but not limited to fire hydrants, Fire Department connections, street alarm boxes, fire escapes, etc.)
- S2 Heaters.** LPG heaters are not permitted on the sidewalk in the pedestrian path of travel.
- » Any use of a portable heater, portable generator, candles, open flame or any activity regulated by Fire Code must be approved and permitted by the San Francisco Fire Department separately from this provisional permit.
 - » Electric heaters may be used if applicant obtains an [electrical permit from the Department of Building Inspection](#) for an exterior mounted weatherproof electrical outlet. Proof of completed job card required.

- S4 Accessible Route.** Sidewalk Shared Spaces must maintain a continuous 8-foot minimum width pedestrian accessible route clear of obstructions at all times along the entire property frontage, including adjacent properties if applicable to their permit. Special conditions where an 8-foot path is not feasible will be reviewed on a case-by-case basis, and this exception requires approval from the Public Works Disability Access Coordinator during the permit review process.

The accessible route width is the width from any shared space element to the nearest obstruction (including existing utilities, signs, poles, tree wells, etc.), landscape area, curb, or other element that restricts pedestrian travel. The accessible route width shall in no case be less than 6 feet. Per the SF Better Streets plan, the accessible route should not meander and should be a straight path of travel for pedestrians to navigate easily along the entire block.



S3 Diverters. The business must utilize pedestrian diverters on each side of the outdoor dining area to guide pedestrians around the business operations. The objects within the sidewalk space may not extend beyond the depth of the diverters at any time.

The diverters must be:

- » At least 30 inches high (H), 12 inches wide (W), and 24 inches long (L)
- » Solid within at least 24 inches off the ground
- » Sturdy, stable, and heavy enough so they cannot tip over or be blown away by the wind
- » Distinctly visible to the visually impaired with contrasting colors.
- » Removable after business closure every day
- » Flush with the building at approximately 90 degrees
- » Free of advertising

S3 Pedestrian Diverter

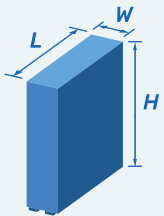

L = length (≥ 24")

W = width (≥ 12")

H = height (≥ 30")

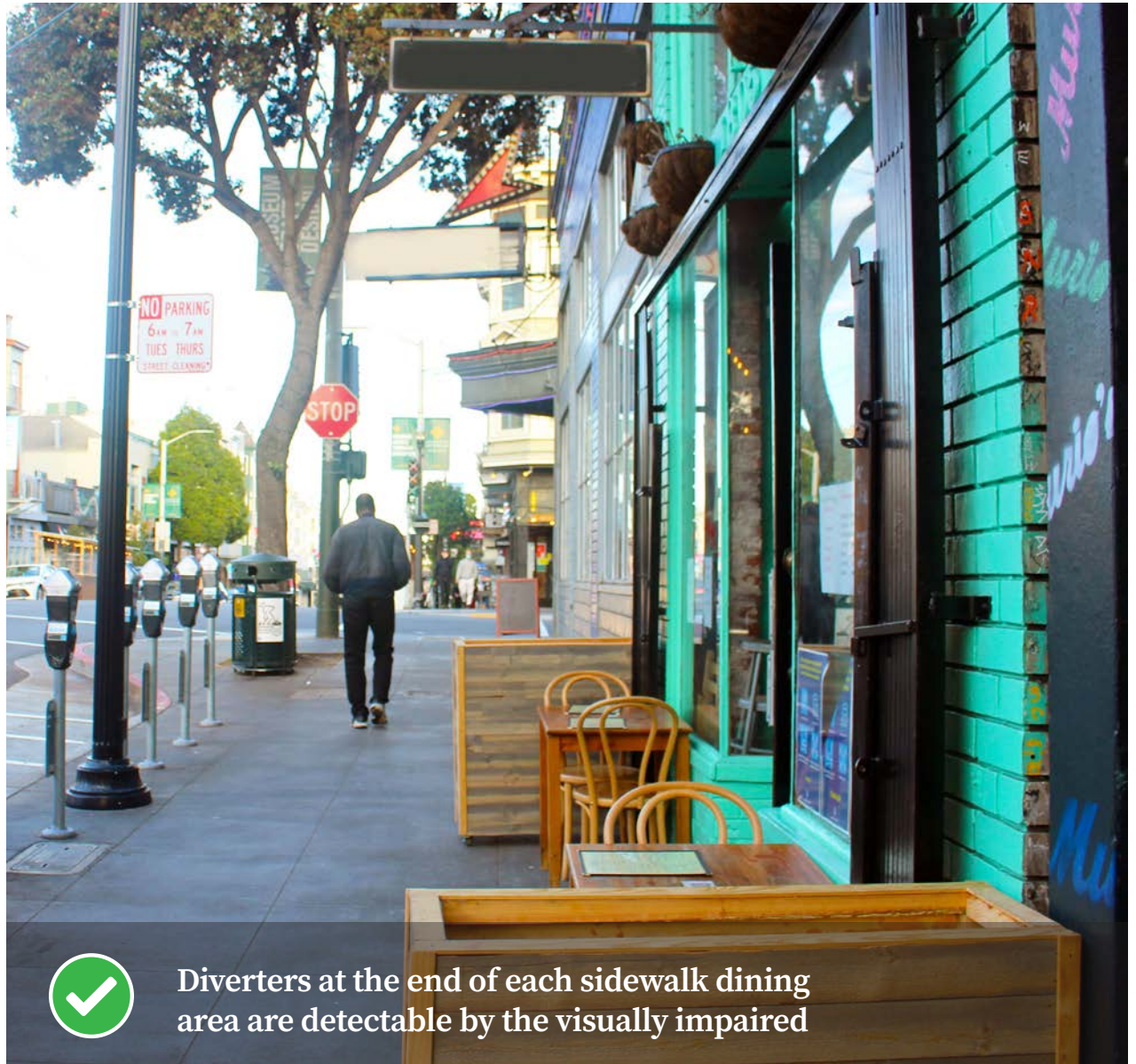

Diverters at the end of each sidewalk dining area are detectable by the visually impaired

S5 Overhead Objects. Hanging or overhead objects, including umbrellas, must have a clearance of at least 7 feet (or 84 inches) from the ground. Clearance under awnings and canopies shall comply with San Francisco Building Code requirements.

S6 Trays and Carts. Food trays or carts, receptacles for dirty dishes, trays or carts for linen and utensils, and cooking appliances shall not be placed or stored on any portion of the sidewalk area.

S7 Bins. Trash, recycling, and compost bins shall be provided within the approved area, but always kept clear of all 3ft emergency access gaps. These bins can be kept inside the restaurant. All bins must be brought inside at end of business day.

S8 Sidewalk Modifications. No modifications may be made to the public sidewalk, including stickers or spray paint, other than social distancing markings. Any markings must be in accordance with [Public Works Order 203,240](#). No furniture may be fixed or bolted to the sidewalk.

S9 Accessible Furniture. Applicants must provide at least one (1) accessible table available for wheelchair users for each type of Shared Space. Accessible dining surfaces shall be dispersed throughout each shared space for each type of seating in a functional area, in accordance with CBC Chapter 11B. See [Section 5: Appendices](#) for more information about accessible furniture requirements.

S5 Overhead Objects



APPLICATION CHECKLIST

See [Section 5: Appendices](#) for a checklist of items to prepare for the digital permit application submittal.



P Parking or Curbside Lane Shared Spaces



The curbside lane is the space on the road closest to the curb, often the parking lane. The curb has many uses and functions, serving the needs of a block and a neighborhood in different ways.

San Francisco has defined how these functions and users are prioritized in different land use contexts in [The City's Curb Management Strategy](#). These key curb functions are: access for people, access for goods, public space and services, storage for vehicles, and movement, including emergency access and public infrastructure operations.

Parking Lane Shared Spaces are mostly used for outdoor dining or retail, and typically involve the construction of a structure, commonly known as a parklet.

Decide what type of parklet you want to implement

TIER 1 Public Parklet: Similar to the City's pre-COVID parklets, a fixed structure providing full-time, publicly accessible space and no commercial activity.

TIER 2 Movable Commercial Parklet: A space occupied by the operator using movable fixtures during limited business hours with a bench or other public seating facility. Operators must choose up to 3 consecutive time blocks of the following available blocks: 8am to Noon, Noon to 3pm, 3pm to 6pm, and 6pm to 10pm.

TIER 3 Commercial Parklet: Similar to existing Shared Spaces, a fixed structure where an operator uses the parklet for commercial activity during business hours with a bench or other public seating facility, and is otherwise open to the public during non-commercial daytime hours, even when the operator's business is closed.

TIER	TYPE	PUBLIC ACCESS	COMMERCIAL ACTIVITY	DAILY OCCUPANCY	CONSTRUCTION
1	Public Parklet	Entire facility during daylight hours through 10pm	None	24/7	Fixed Structure
2	Movable Commercial Parklet	At least one bench during hours of commercial operation	8am to 12pm 12pm to 3pm 3pm to 6pm 6pm to 10pm	Up to 3 consecutive blocks from the available time block options	Movable Fixtures
3	Commercial Parklet	At least one bench during hours of commercial operation. Otherwise, entire facility during daylight hours through 10pm	During hours of operation	24/7 (operator may secure their parklet from 12am to 7am)	Fixed Structure



Location and Site Treatments

Your Shared Spaces must not obstruct pedestrian visibility, crosswalks, bicycle lanes, traffic signals or other traffic warning devices.

CONTENTS

- Where can I place my structure?
- Visibility at Intersections
- Setback or Buffer
- Utilities
- Drainage
- Wheel Stop and Flexible Delineator Post Placement
- Signage System



Location and Site Treatments

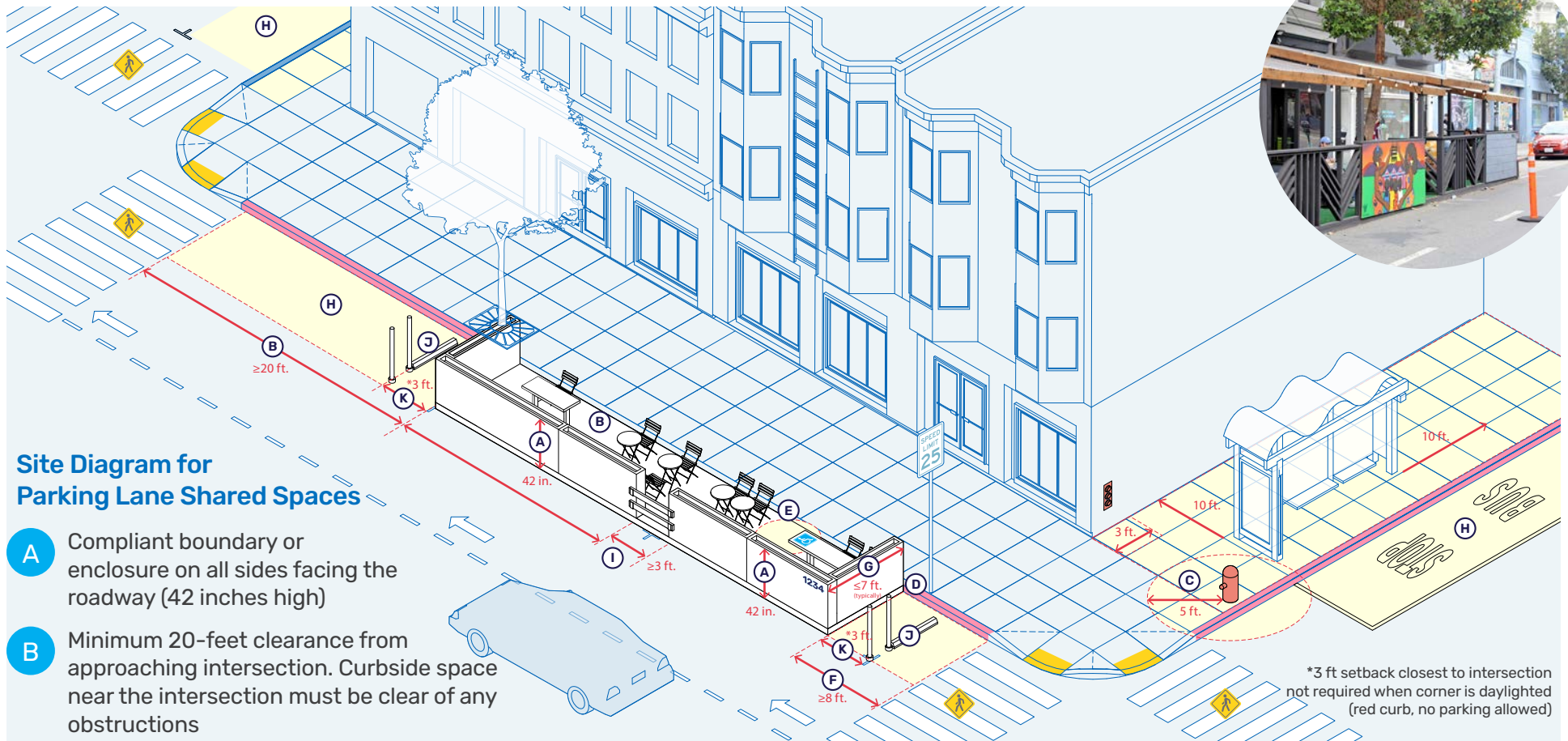

Where Can I Place My Structure?



P1 Length:

- *Parallel parking:* maximum 2 parking spots or 40 linear feet, including setbacks and emergency gaps
- *Angled or perpendicular:* 20 linear feet

P2 Setbacks: 3-foot setback or buffer from each end of the marked parking space for parallel, angled, or perpendicular parking spaces

P3 Width:

- *Parallel parking:* full width of parking lane (7 feet max)*
- *Angled or perpendicular:* 14 feet max*

*Exceptions may apply along rail, cable car, or other special cases that would necessitate reducing the width of the zone.

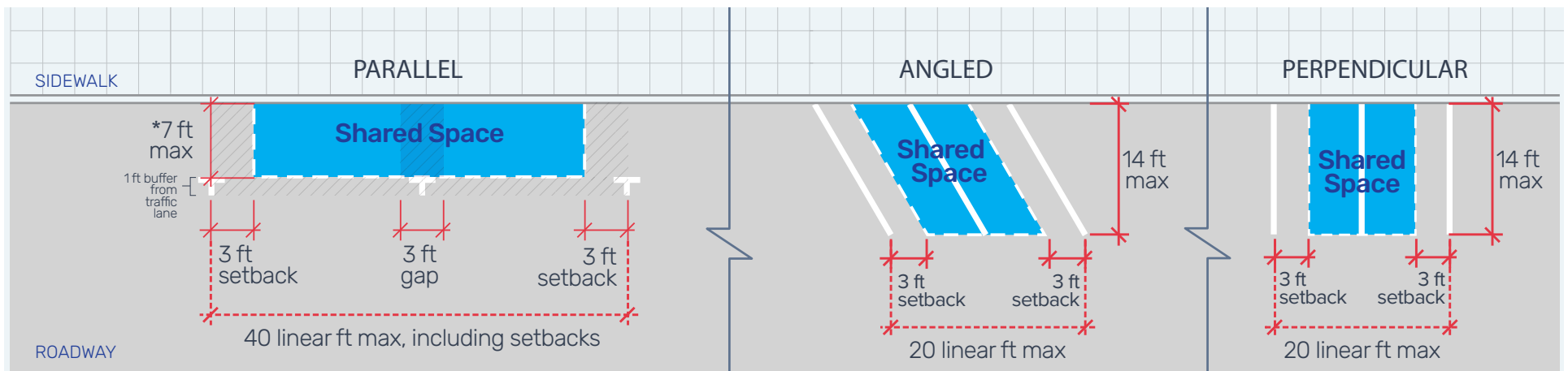

Where Can I Place My Structure?

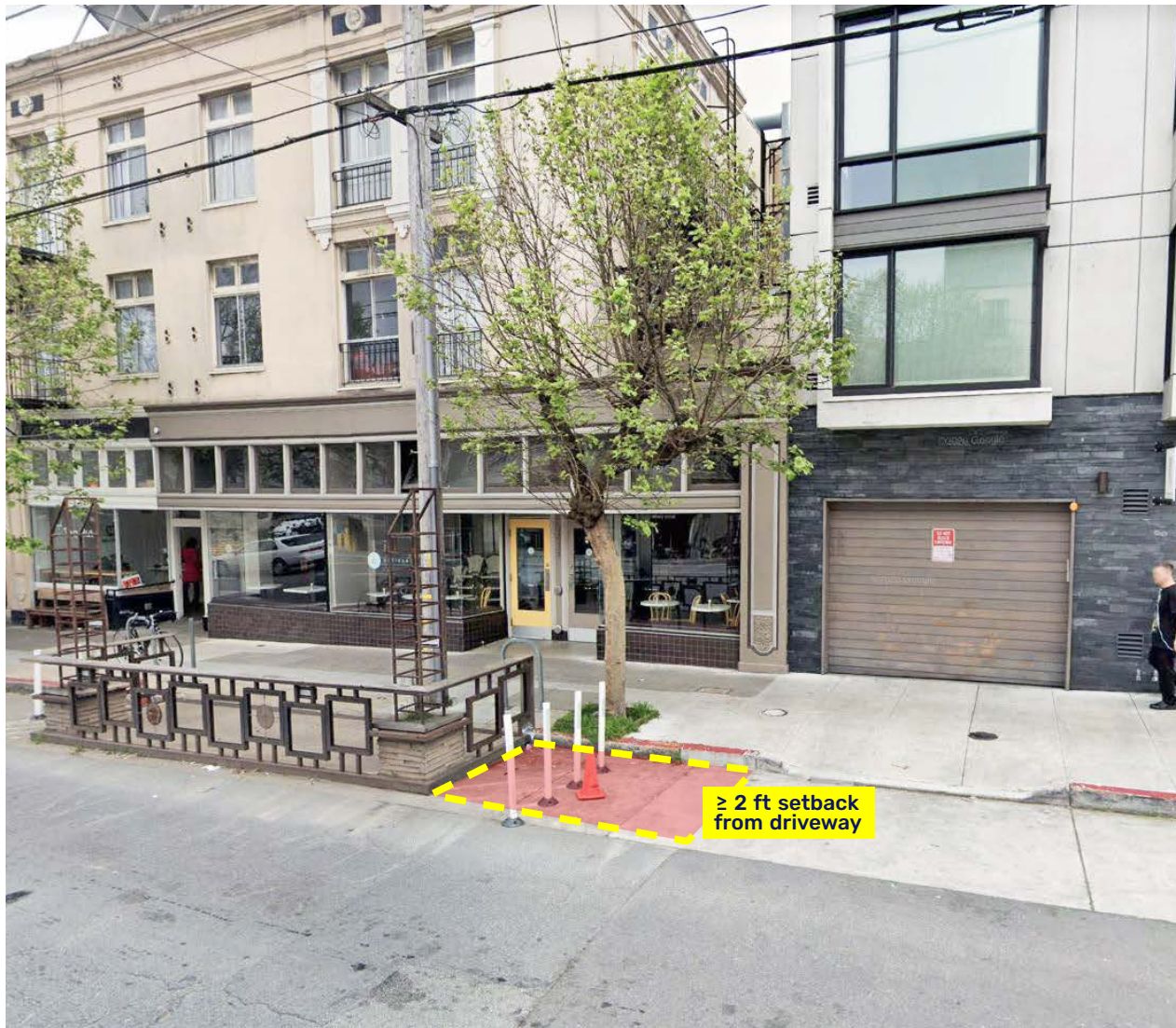

P2 Setbacks: All structures must maintain a setback of at least 2 feet from an active driveway or curb cut.

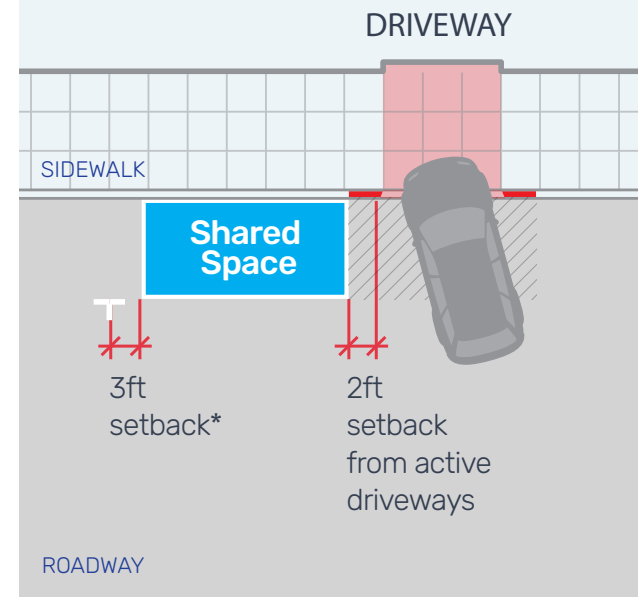

Street Slope



P4 Slope: The cross slope on the Parklet surface shall not exceed 2% in any direction. If proposed on a street grade greater than 5% additional design requirements and review may be required to make the space accessible to the maximum extent technically feasible as defined in the California Building Code.

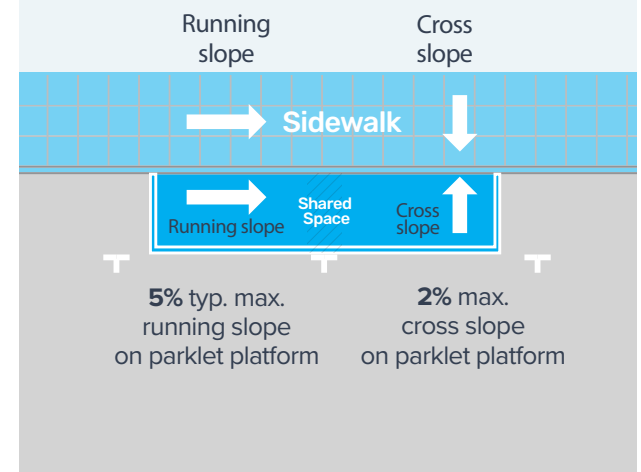

Visibility at Intersections: Daylighting

Daylighting is pedestrian safety treatment that is a key component of intersections across the city. Daylighting increases the visual field of both pedestrians crossing the street, and drivers pulling up to an intersection. The diagram below shows how setting back your parklet structure from crosswalks increases pedestrian safety.

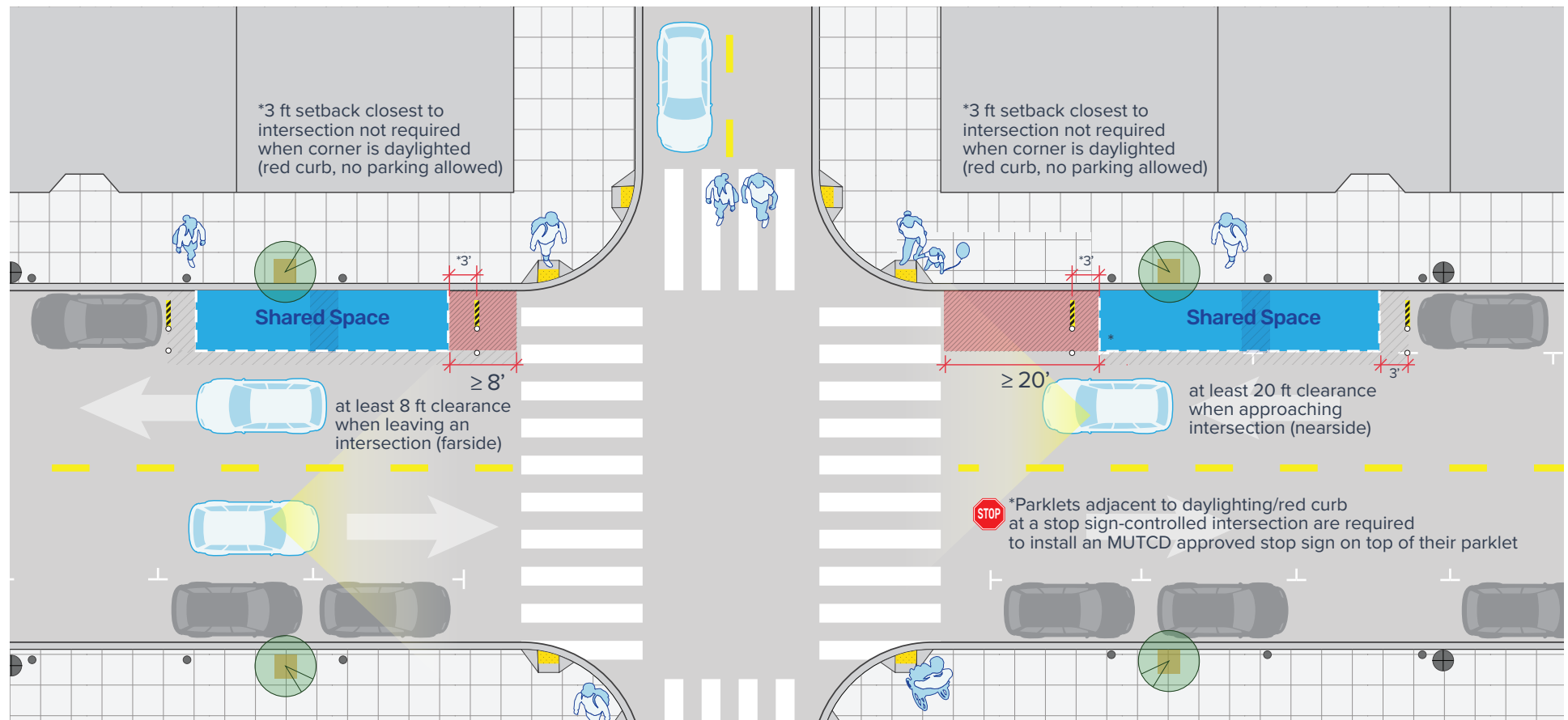

Visibility at Intersections

Parklet structures should be highly visible to other users of the road. Setbacks and other traffic control devices are standard site treatments for parklets.



PLACEMENT REQUIREMENTS

- Minimum 20-foot clearance from approaching intersection (nearside). Curbside space near the intersection must be clear of any obstructions
- Minimum 8ft clearance when exiting an intersection (farside).

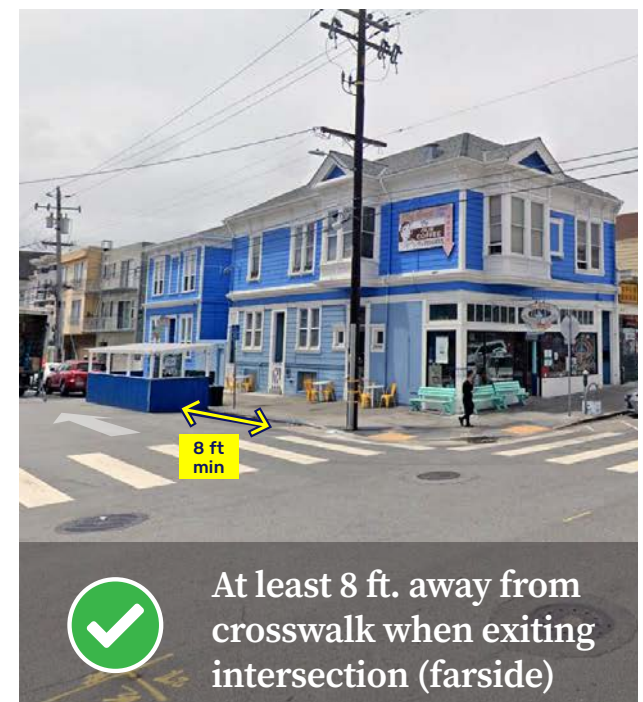

Visibility at Intersections

Your Shared Spaces must not obstruct pedestrian visibility, crosswalks, bicycle lanes, traffic signals or other traffic warning devices.



P76 The enclosure should not block the view of traffic, including pedestrian traffic, nor block the view of traffic control devices such as traffic signs, traffic signals, and other traffic warning devices. It should not obstruct motorists' visibility of traffic signals from 200 feet away (about half a block).



Visibility at Intersections

Your Shared Spaces must not obstruct pedestrian visibility, crosswalks, bicycle lanes, traffic signals or other traffic warning devices.

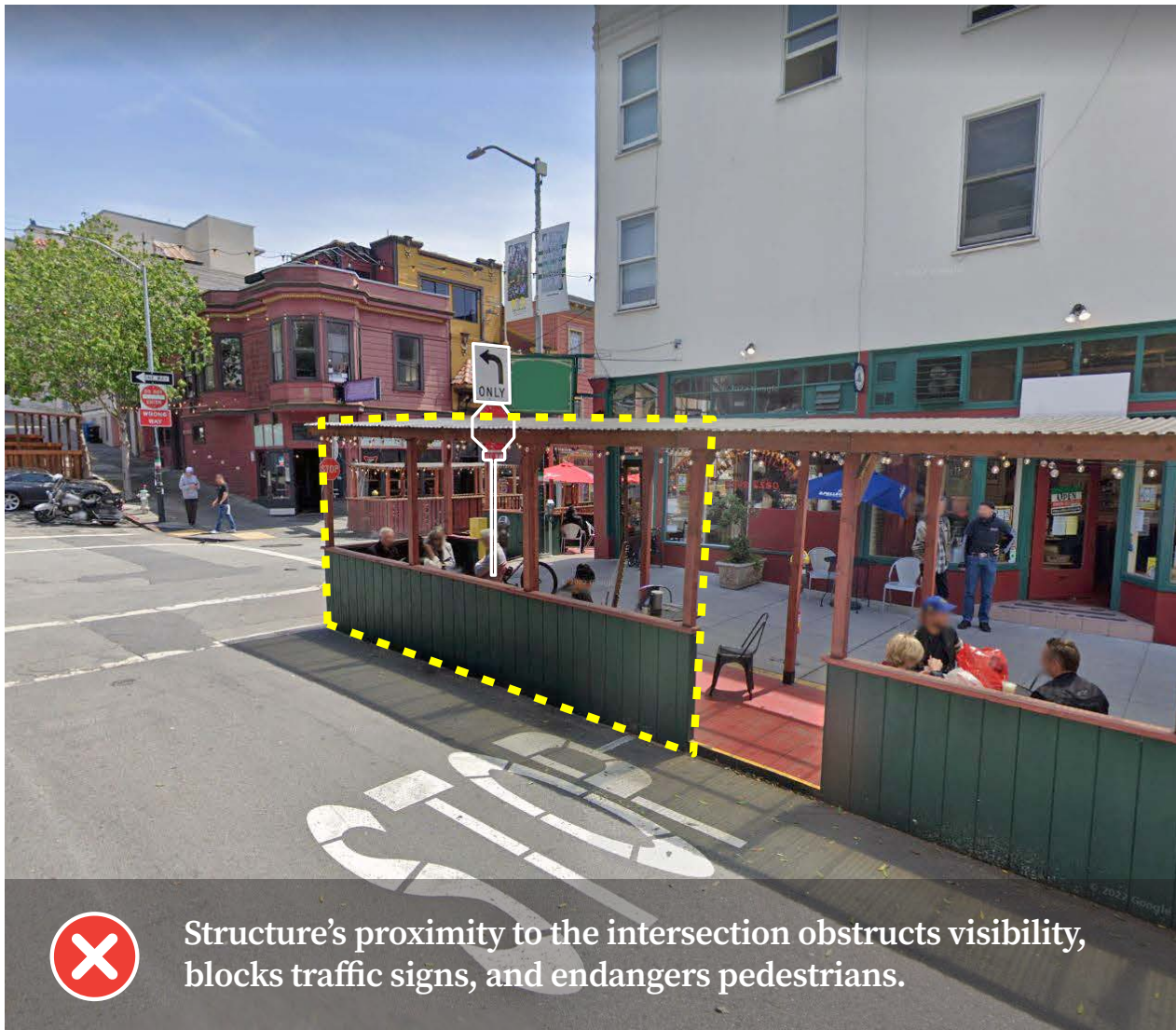

Structure's proximity to the intersection obstructs visibility, blocks traffic signs, and endangers pedestrians.

- Parklets adjacent to daylighting/red curb at a stop sign-controlled intersection are required to install an MUTCD approved stop sign on top of their parklet
- Sign dimensions must be 30 inches x 30 inches



Setback or Buffer

Emergency responders need to move quickly and easily between the street and the sidewalk. Set structures back 3 feet from each end of the parking space, and keep them clear of obstructions.



 Maintains a 3-foot setback at each end of the parklet.

- **P2** A 3-foot setback or buffer from each end of the parklet, or the marked parking space for parallel, angled, or perpendicular parking spaces.
- If abutting another parklet, each must provide a 3-foot setback, for a total of 6 feet between the two.
- These buffers must be kept clear from obstructions like garbage bins, bicycles, motorcycles, or scooters at all times. Signage will be provided.

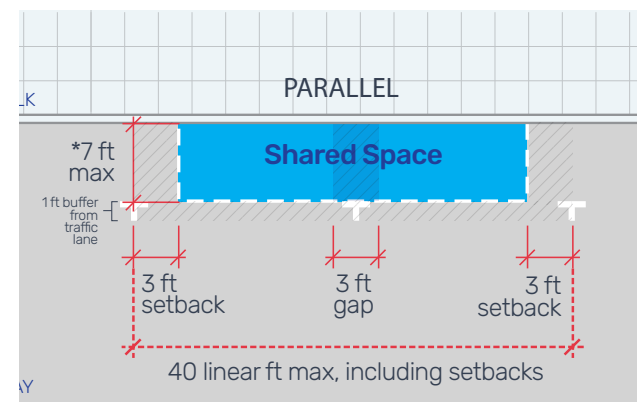

Setback or Buffer

Maintaining a 3-foot setback at each end of the structure facilitates emergency operations.



Maintains a 3-foot setback at each end of the parklet.

- P2 A 3-foot setback or buffer from each end of the parklet, or the marked parking space for parallel, angled, or perpendicular parking spaces
- These buffers must be kept clear from obstructions like garbage bins, bicycles, motorcycles, or scooters at all times. Signage will be provided.
- Note that structures located on angled parking must be angled to match the roadway striping

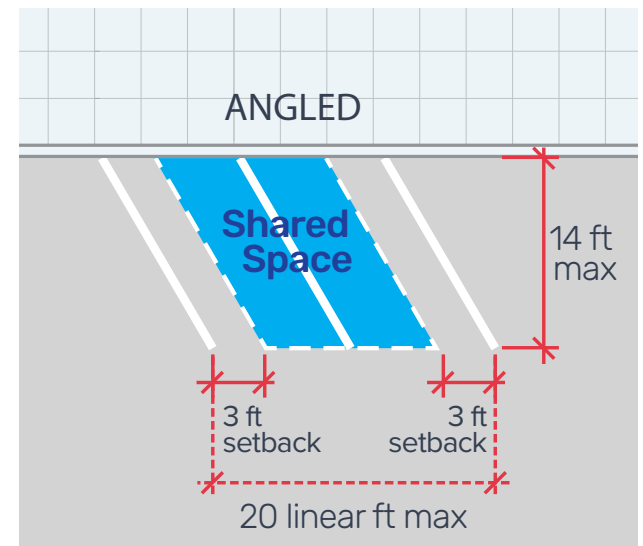

Utilities

Allow access to public utilities for maintenance and repairs.



Location and Site Treatments

MOVABILITY AND PORTABILITY

- Pouring concrete to build ramps or decks is discouraged, as it complicates utility repairs.
- You may use concrete pavers on a platform structure



Removable threshold for easier maintenance



Your structure may not obstruct access to utilities



Modular platforms allow for quick access for City crews.

Drainage

Allow for stormwater drainage flow along the structure, easily accessible for maintenance.

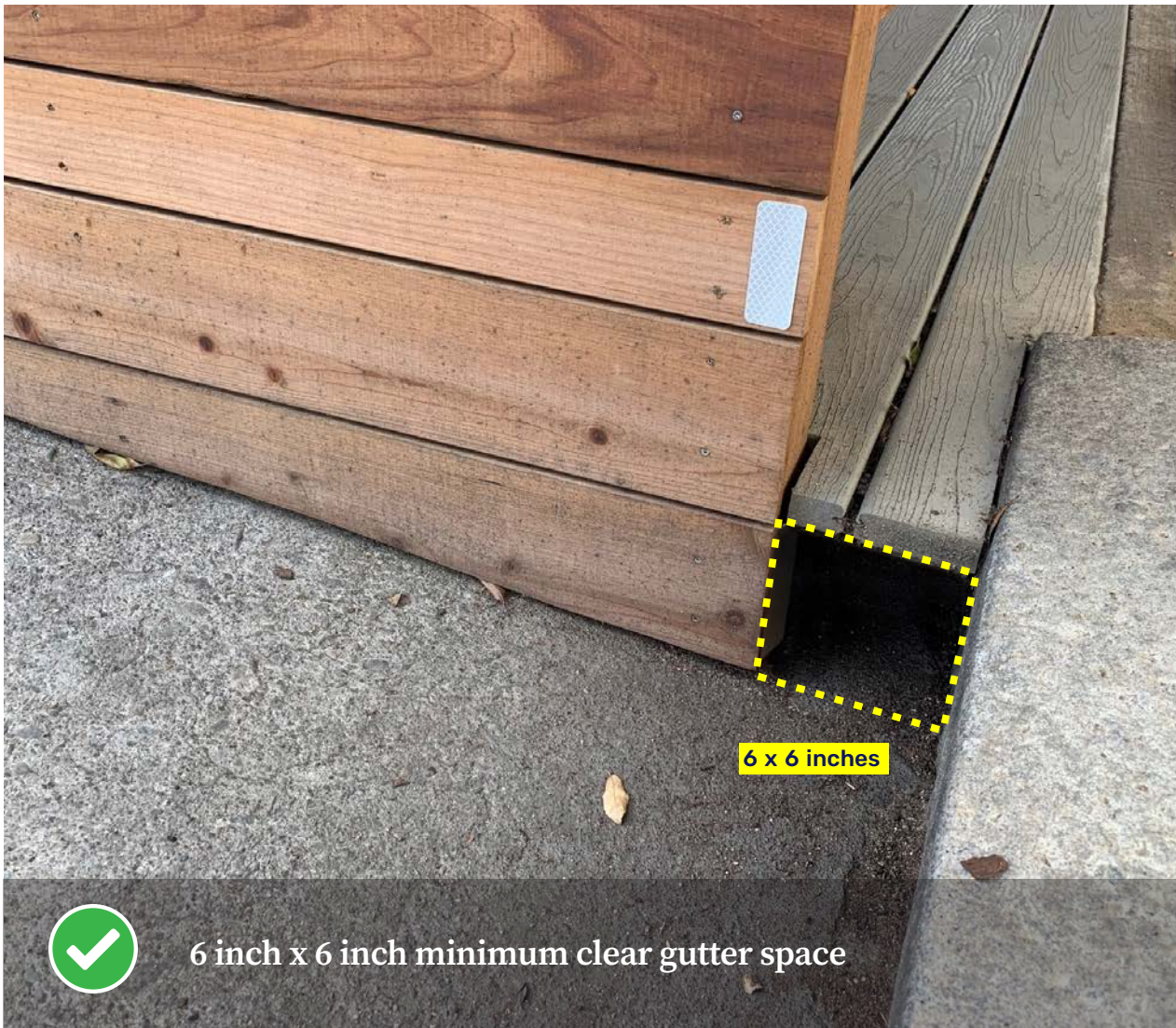

DRAINAGE

- A 6 inch x 6 inch minimum clear gutter space must be provided along the entire length of the proposed platform.

P15 Drainage

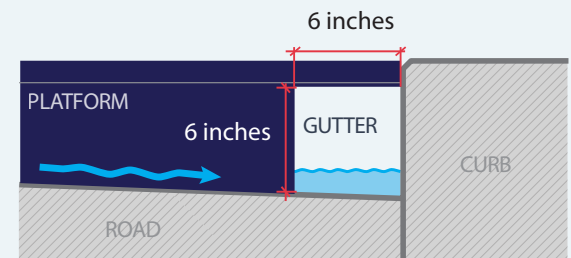
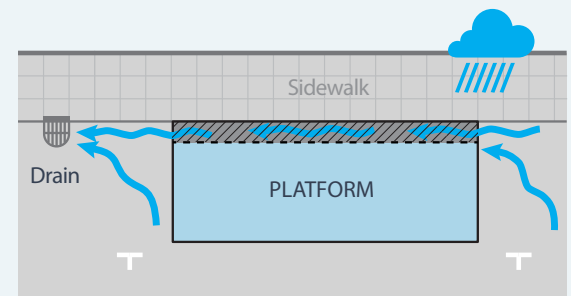

Wheel Stop and Flexible Delineator Post Placement

Your Shared Space shall be visible to other users of the road during the day and night and provide clear delineators of its footprint.



- **Visibility:** You must mark the edges or corners of your enclosure with yellow high intensity retro-reflective tape or reflectors to be visible to drivers at night.
- **Flexible Delineator Posts:** Purchase four standardized flexible delineator posts, two for each end of the parklet.
- **Signage:** The 3-foot setbacks must be kept clear from obstructions like garbage bins, bicycles, motorcycles, or scooters at all times. Signage will be provided.
- See *Appendix page 105* for wheel stop and delineator specifications.

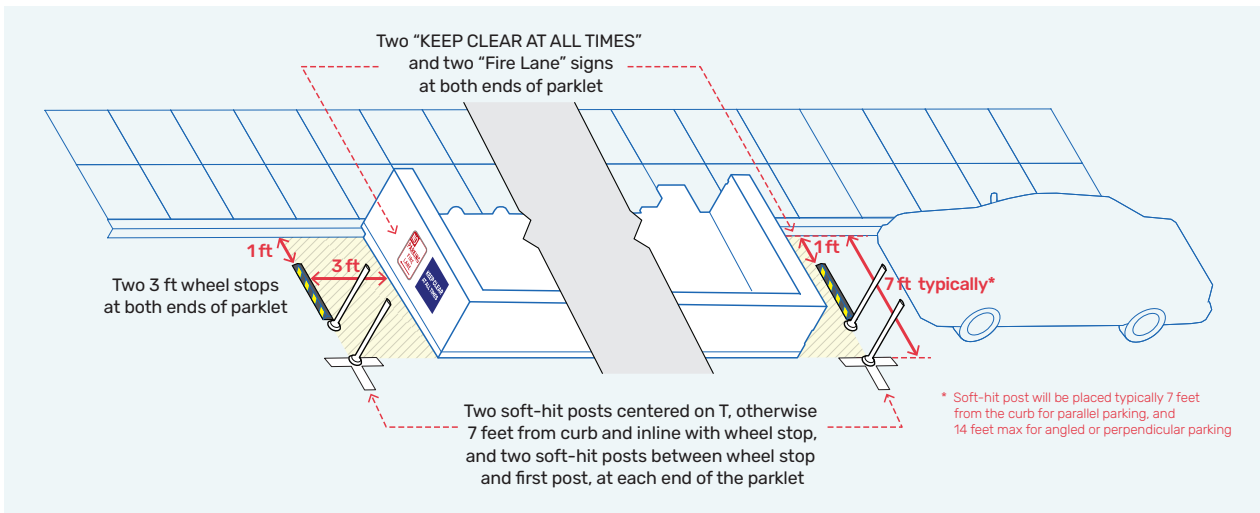

REQUIRED SIGNAGE



Signage System

Signage for the Shared Spaces program will be provided by the City in 2023.

Further instructions on location and placement will be provided to permit holders. No action is needed at this time.

The following are sample images of signage being developed by the Shared Spaces program.

SIDEWALK SIGNAGE



12"

14"

1/8" Anodized aluminum wrapped with laminated digital print. Applied white copy - reflective.

COMMERCIAL PARKLET



12"

18"

1/8" Anodized aluminum wrapped with laminated digital print. Applied white copy - reflective.

PUBLIC PARKLET



12"

18"

1/8" Anodized aluminum wrapped with laminated digital print. Applied white copy - reflective.

OR

KEEP CLEAR AT ALL TIMES



9"

9"

1/8" Anodized aluminum wrapped with laminated digital print. Applied white copy - reflective.

PUBLIC SEATING



8"

3.5"

Vinyl decal. Applied white copy - reflective.

CURBSIDE SIGNAGE

Public Accessibility

All Shared Spaces shall remain accessible to the public.

- Fixed Commercial Parklets and Movable Commercial Parklets shall provide alternate public seating, which is accessible to persons who are not patrons of the business for any period when the Curbside Shared Space is being activated for commercial use by the business.
- Alternate public seating shall include at least one public bench or other seating arrangement for every 20 linear feet of Curbside Shared Space, or per subdivided section of a Curbside Shared Space.
- Fixed Commercial Parklet and Movable Commercial Parklet Permittees shall be allowed to secure the Curbside Shared Space from midnight to 7:00 a.m. The public bench may be part of the portion that is secured between those hours.
- Emergency access gaps will need to remain unobstructed between the street and sidewalk.

Public Access by Parklet Type

TIER	TYPE	PUBLIC ACCESS	COMMERCIAL ACTIVITY	DAILY OCCUPANCY	CONSTRUCTION
1	Public Parklet	Entire facility during daylight hours through 10pm	None	24/7	Fixed Structure
2	Movable Commercial Parklet	At least one bench during hours of commercial operation	8am to 12pm 12pm to 3pm 3pm to 6pm 6pm to 10pm	Up to 3 consecutive blocks from the available time block options	Movable Fixtures
3	Commercial Parklet	At least one bench during hours of commercial operation. Otherwise, entire facility during daylight hours through 10pm	During hours of operation	24/7 (operator may secure their parklet from 12am to 7am)	Fixed Structure



Fire Safety & Emergency Access

Emergency responders utilize the most direct path to access a building from the street to assist citizens in need of medical attention or for firefighting operations. You must provide enough clearance for responders to maneuver and operate through and around the structure. Obstructing emergency access may lead to immediate danger to health or life safety.

CONTENTS

- Emergency Access
- Sightlines and Visibility
- Structure Height
- Roofs and Canopies
- Space Heaters
- Electrical cords and cables
- Address Display



Emergency Access: 3-Foot Gap

Emergency responders must access sidewalks and buildings quickly from the street. Parklets should have a 3-foot emergency access gap (for every 20 linear feet), open to the sky and free of any obstacles.



ADDITIONAL REQUIREMENTS

P19 The emergency access gap must be kept clear of any obstacles like tables, chairs, barricades, bike racks, trees, poles, and etcetera at all times

P20 You're required to place a rigid, removable barrier at these access gaps



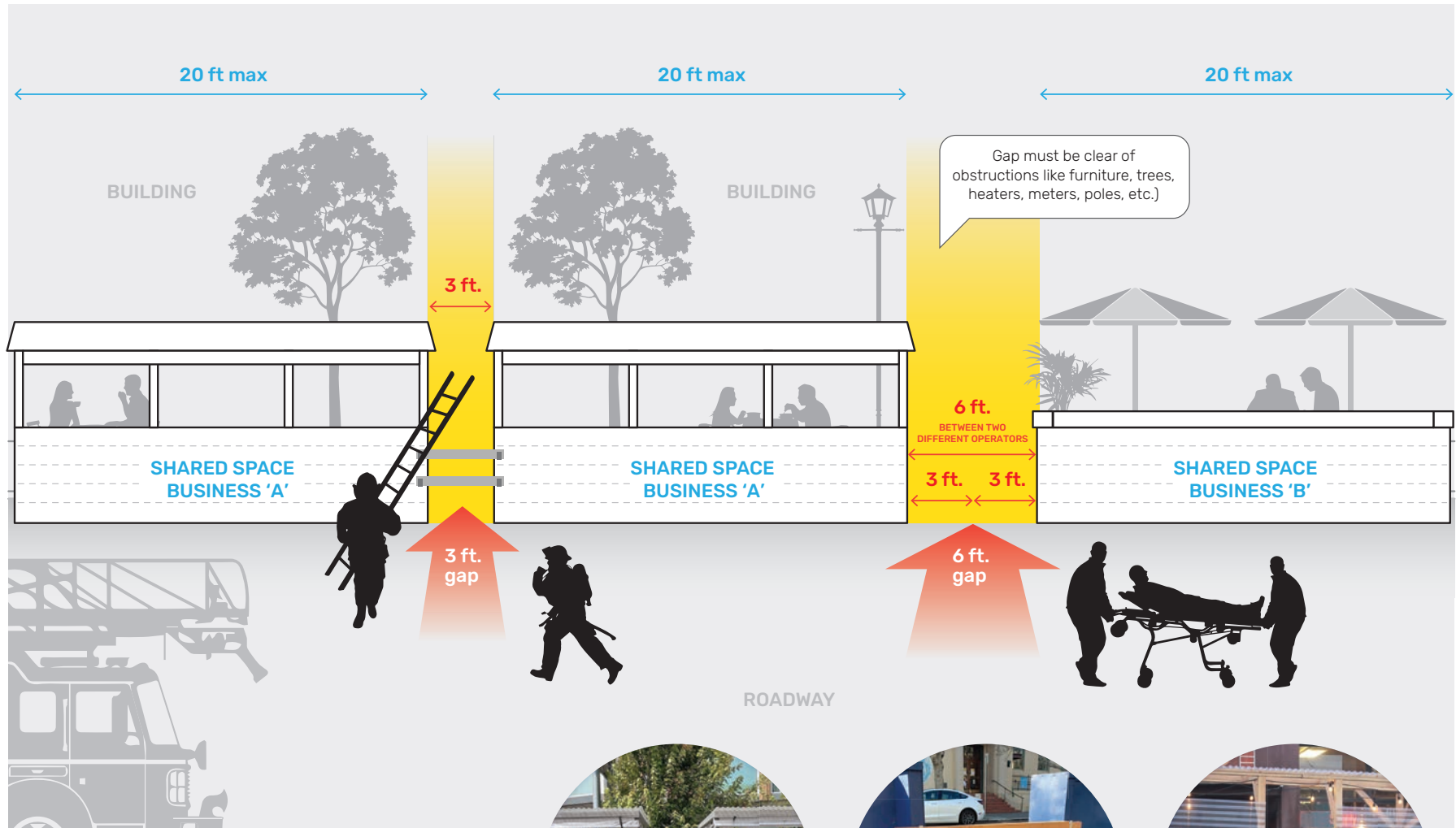

Minimum 3-foot emergency access gap required for every 20 feet of structure, with vertical and horizontal clearance from street to building.

Gap must be clear of obstructions like furniture, trees, heaters, meters, poles, etc.)

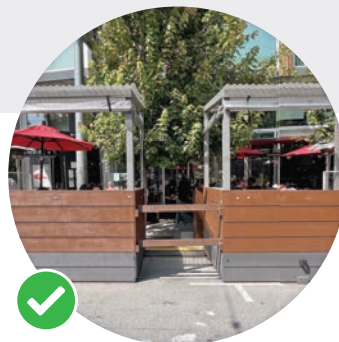

This is a compliant 3-foot gap with a clear path and no overhead obstructions.

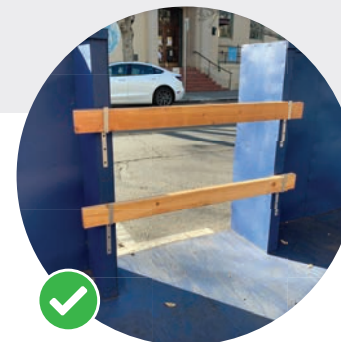

Provide a rigid, easily-removable barrier at the 3-foot gaps.



This is a non-compliant gap because of the overhead and pathway obstructions.

Emergency Access: Removable Barrier

Visually impaired people need to a detectable barrier to prevent them from walking out into the street. Emergency responders need to move easily between the street, parklet, and sidewalk.

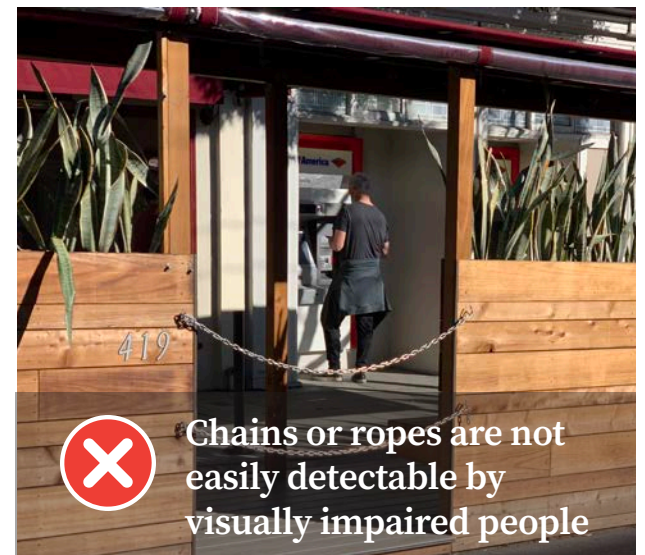
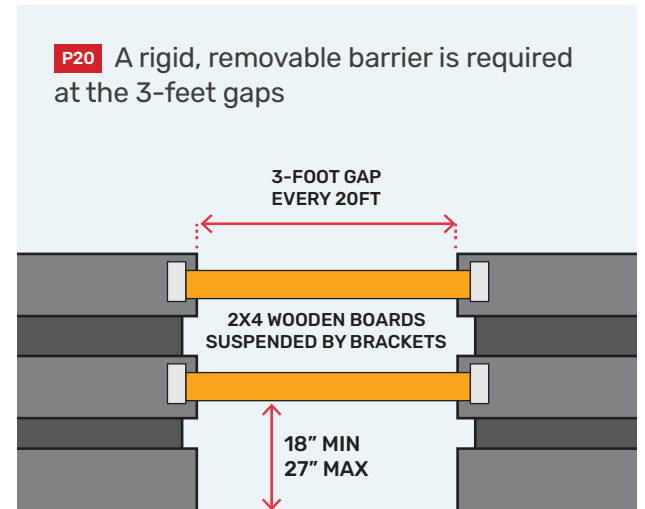

Barriers help visually impaired but are easily moved in emergencies



Chains or ropes are not easily detectable by visually impaired people

Emergency Access: Obstructions

Ensure the 3-foot emergency access gaps are open to the sky and free of any obstacles.



Emergency Access: Obstructions

Emergency responders must be able to access sidewalks and buildings quickly from the street, at all times.

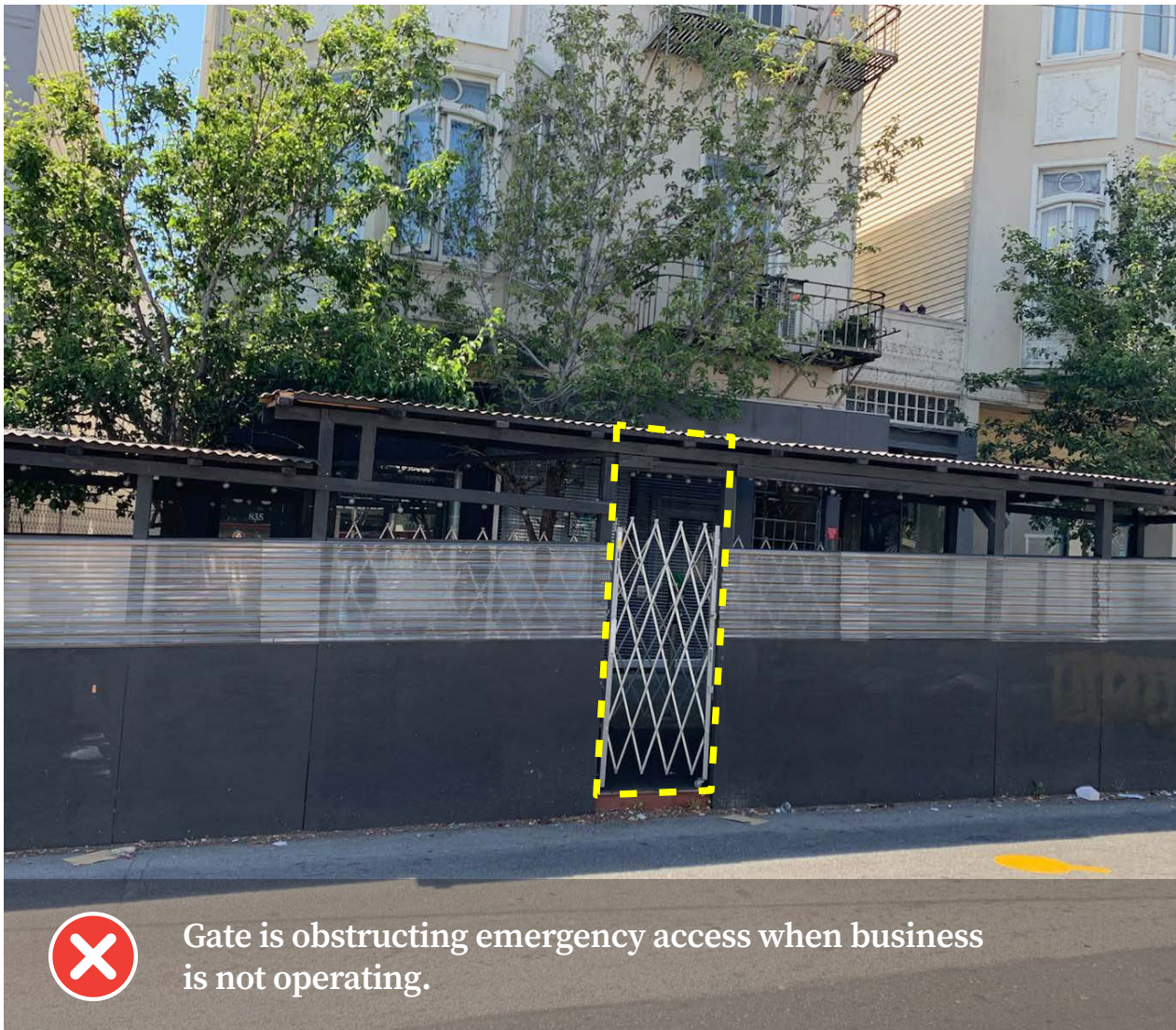

P19 If you choose to secure your commercial-use parklet (allowed from 12am to 7am), emergency access clearance must be maintained at all times

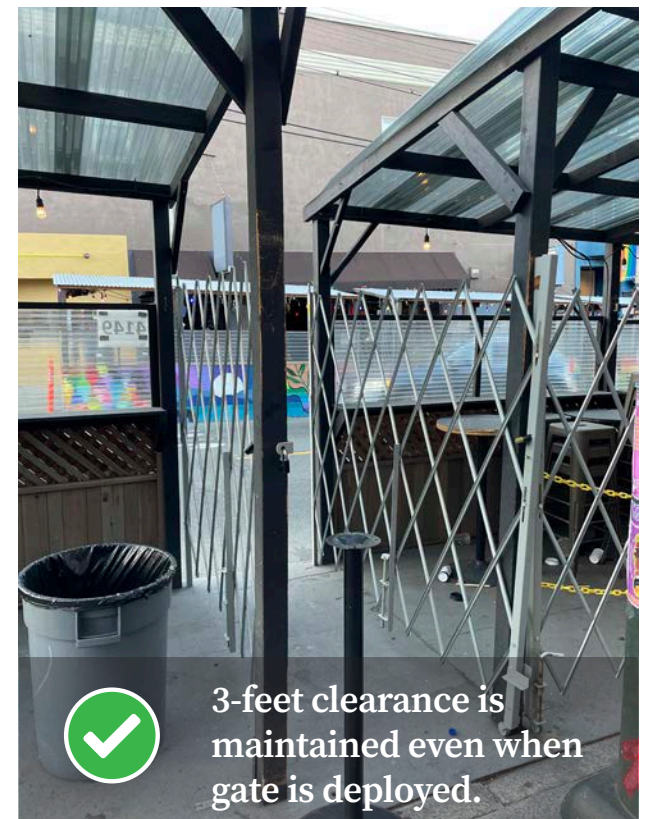

Sightlines and Visibility

Allow first responders to view buildings, sidewalk, and surroundings from the street, through your structure.

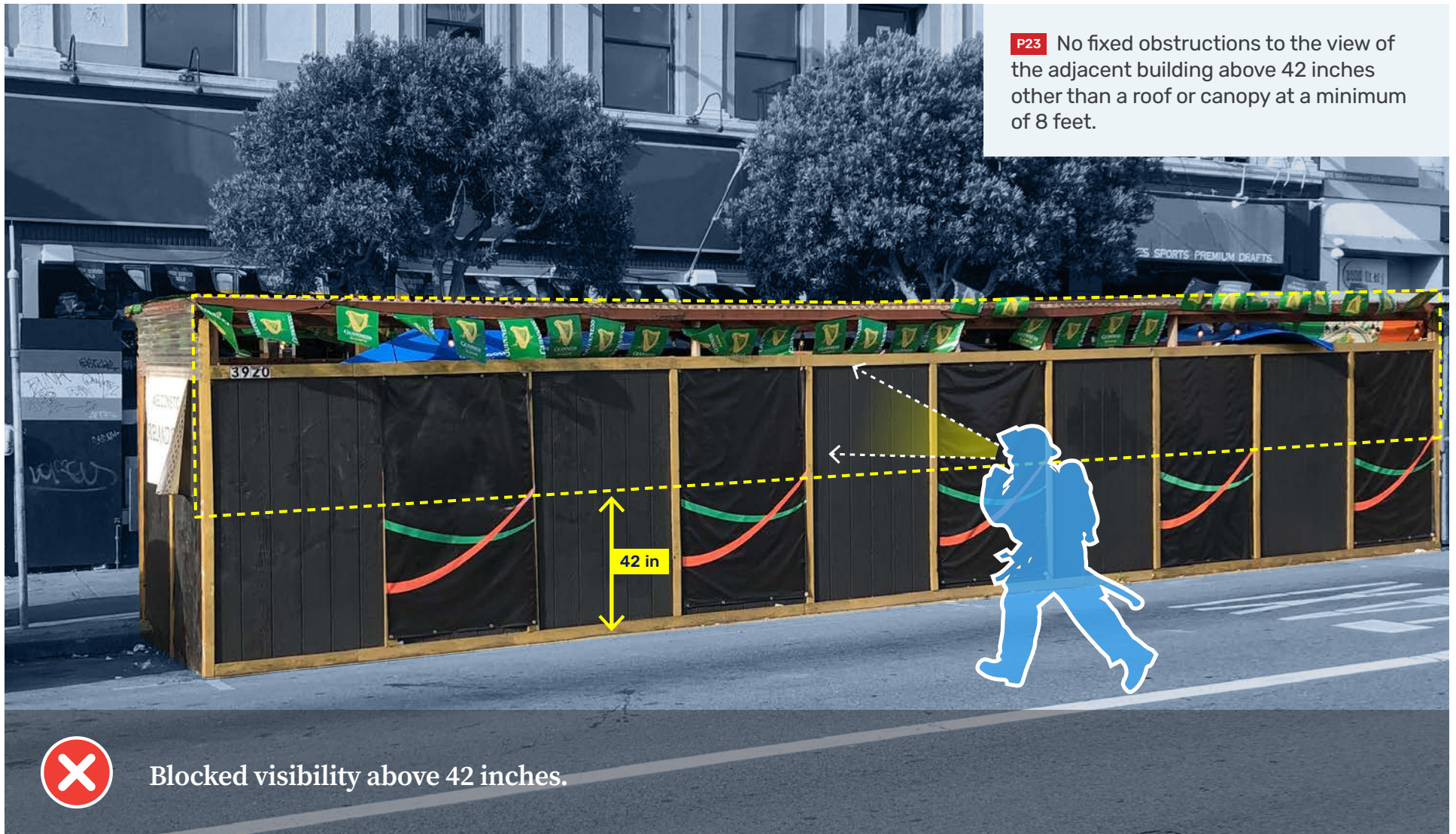

Sightlines and Visibility

Emergency responders need to see sidewalks, building doors and windows through the parklet structure. Keep sightlines above 42 inches clear of visual obstructions.

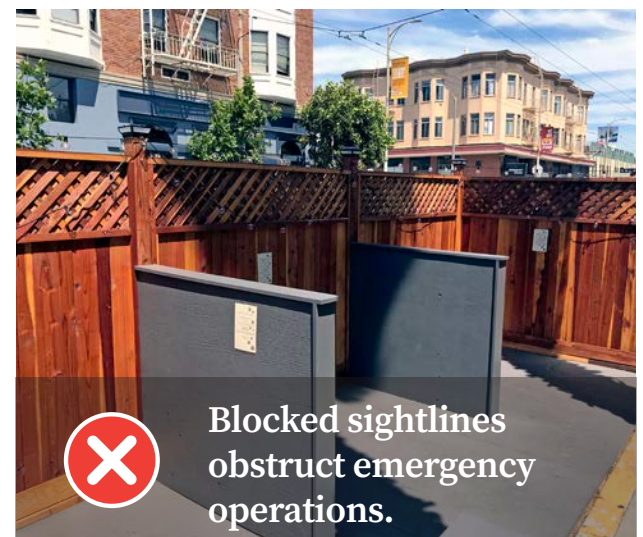
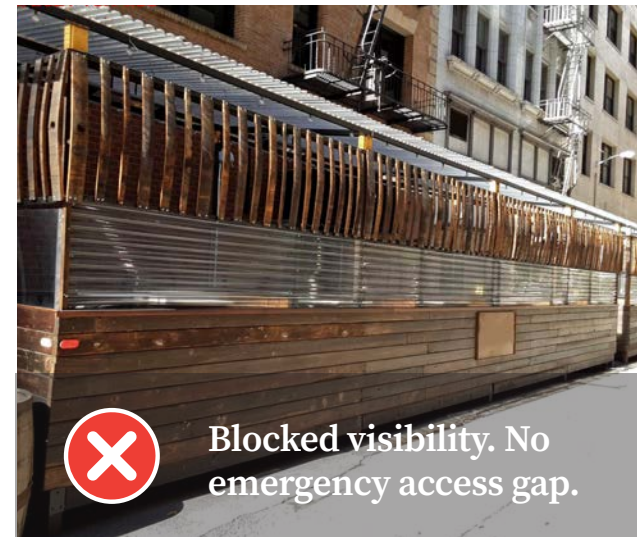
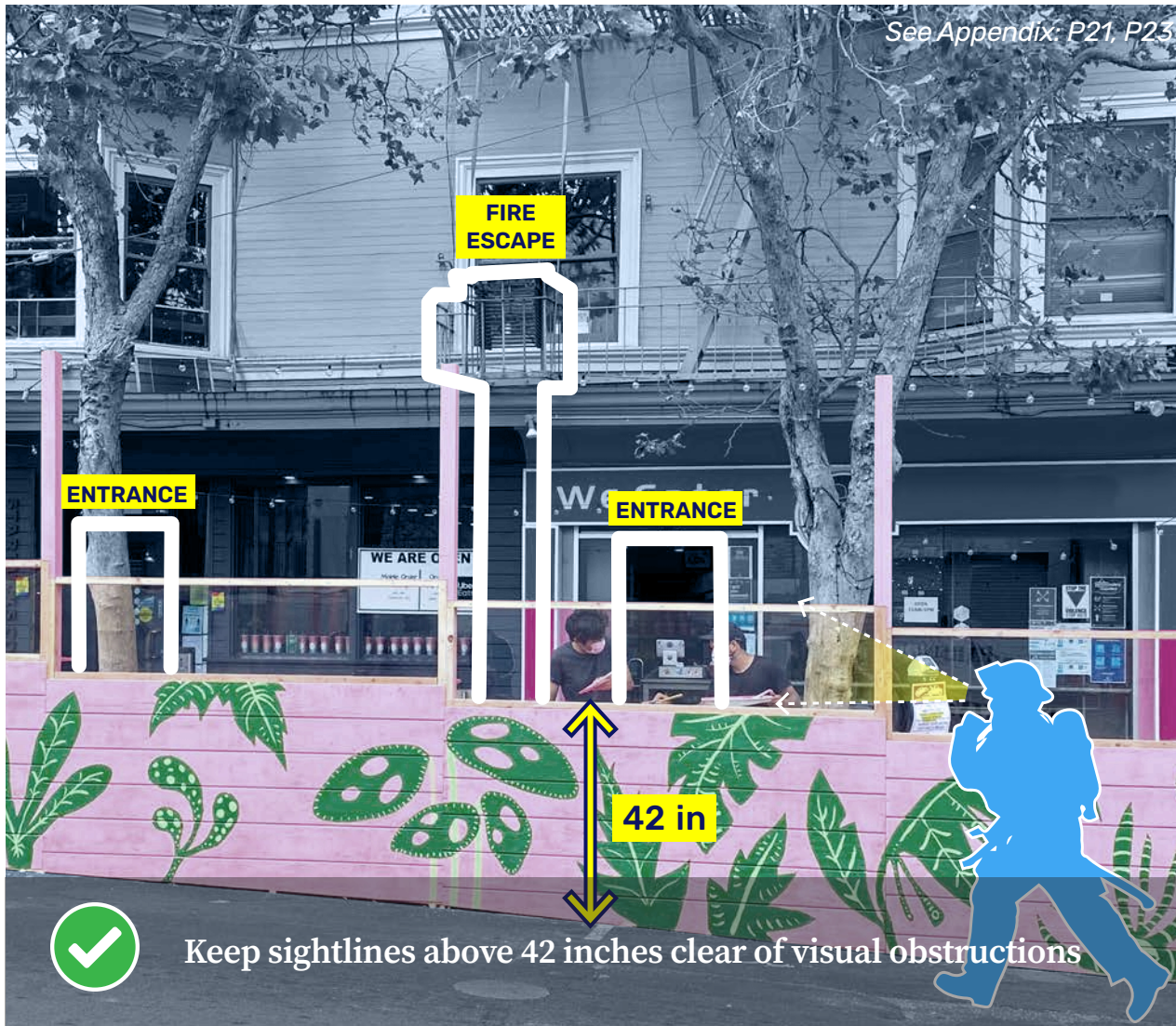

Sightlines and Visibility

Allow first responders to view buildings, sidewalk, and surroundings from the street, through your structure.

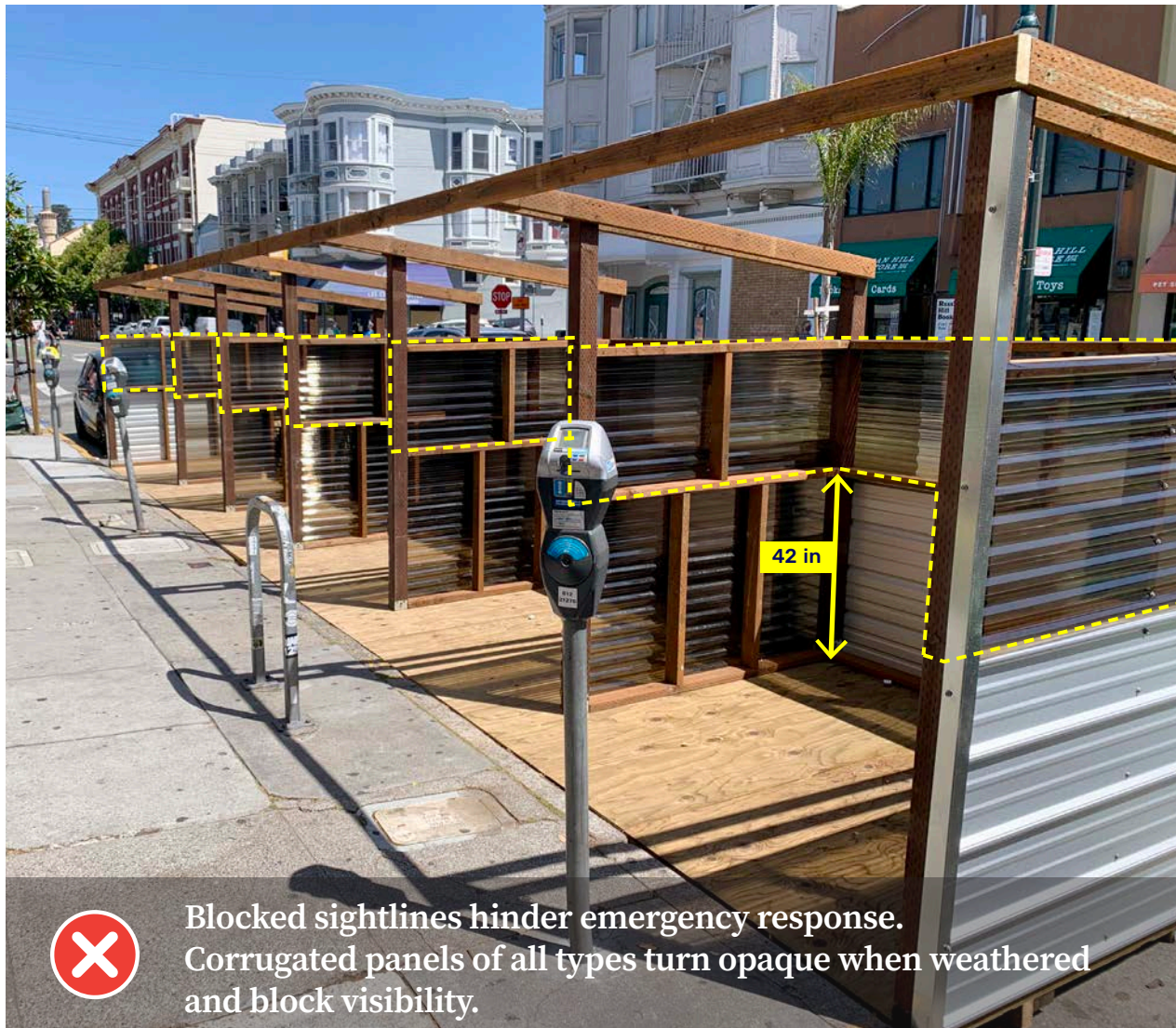

- If you choose to install enclosure panels above 42 inches to block the wind, you must use transparent materials
- Corrugated panels are not recommended because they tend to weather and become opaque

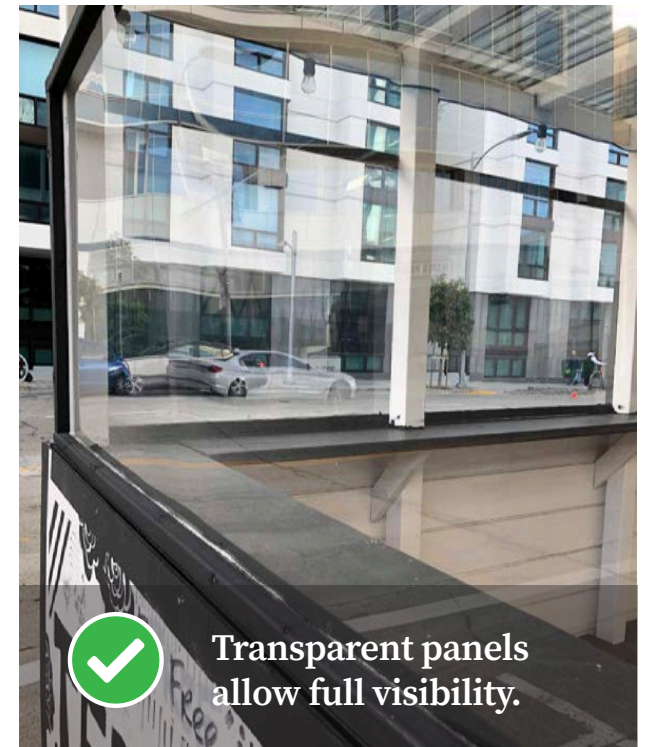

Structure Height

You structure should be 10 feet maximum in height, with a minimum 7 feet head clearance within the structure itself.

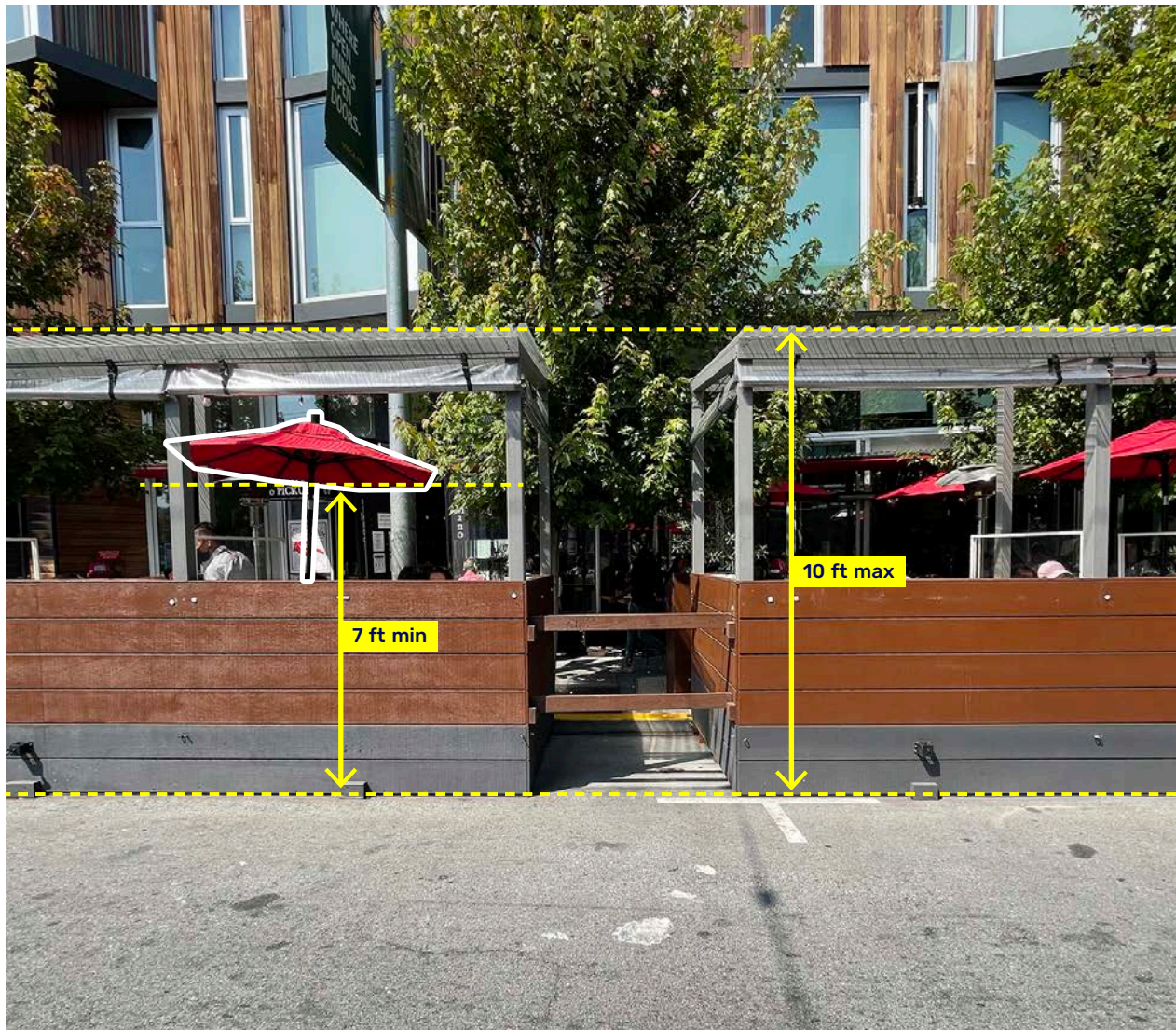

ADDITIONAL REQUIREMENTS

P26 No part of the structure shall exceed 10 feet in height, (including poles, posts, canopies, wires, string lights, signs, or pergolas)

P26 If Muni overhead lines are present, the top of the structure (including any roof) must not be taller than 9 feet above the road



Roofs and canopies

Your structure, including roofs or canopies, should allow proper operation of emergency equipment, like Fire Department ladders, and access to fire escape ladders.



Structure and canopy extend onto the sidewalk, obstructing emergency operations.

- P24** No canopies/roofs on parklets shall be permitted when sidewalk is less than 10 feet wide
- P25** No part of the parklet structure shall extend over the curb or sidewalk

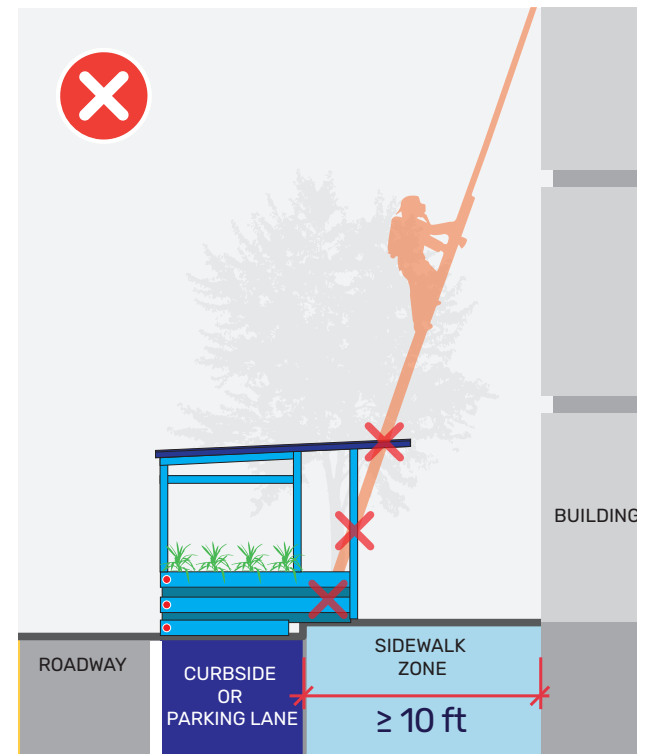

Roofs and canopies

Your structure, including roofs or canopies, should allow proper operation of emergency equipment, like Fire Department ladders, and access to fire escape ladders.



P24 No canopies/roofs on parklets shall be permitted when sidewalk is less than 10 feet wide

P25 No part of the parklet structure shall extend over the curb or sidewalk

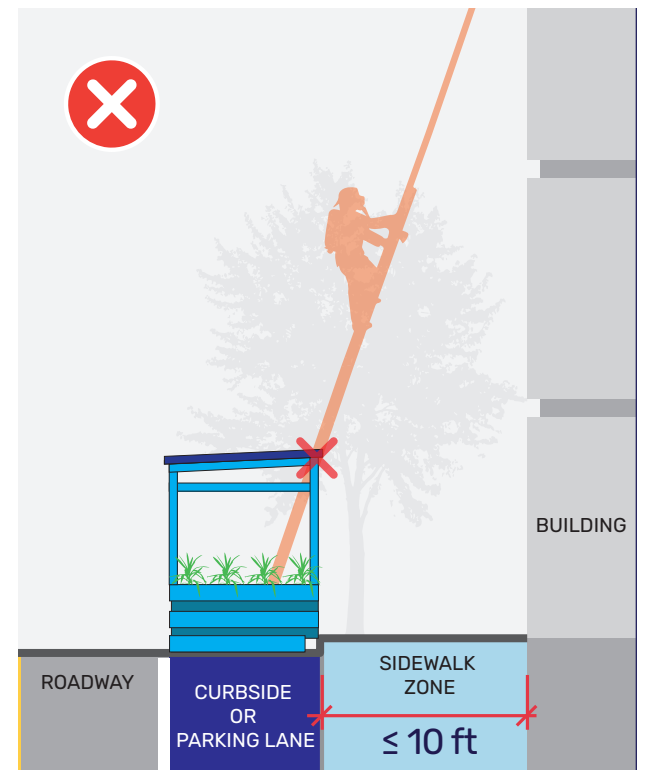

Roofs and canopies

Your Shared Space should allow full and immediate access to fire escape ladders, fire hydrants, or Fire Department connections, and allow proper operation of emergency equipment.



Space Heaters

You must use outdoor heating fixtures safely. Ensure the use and operation of propane heaters complies with SFFD regulations

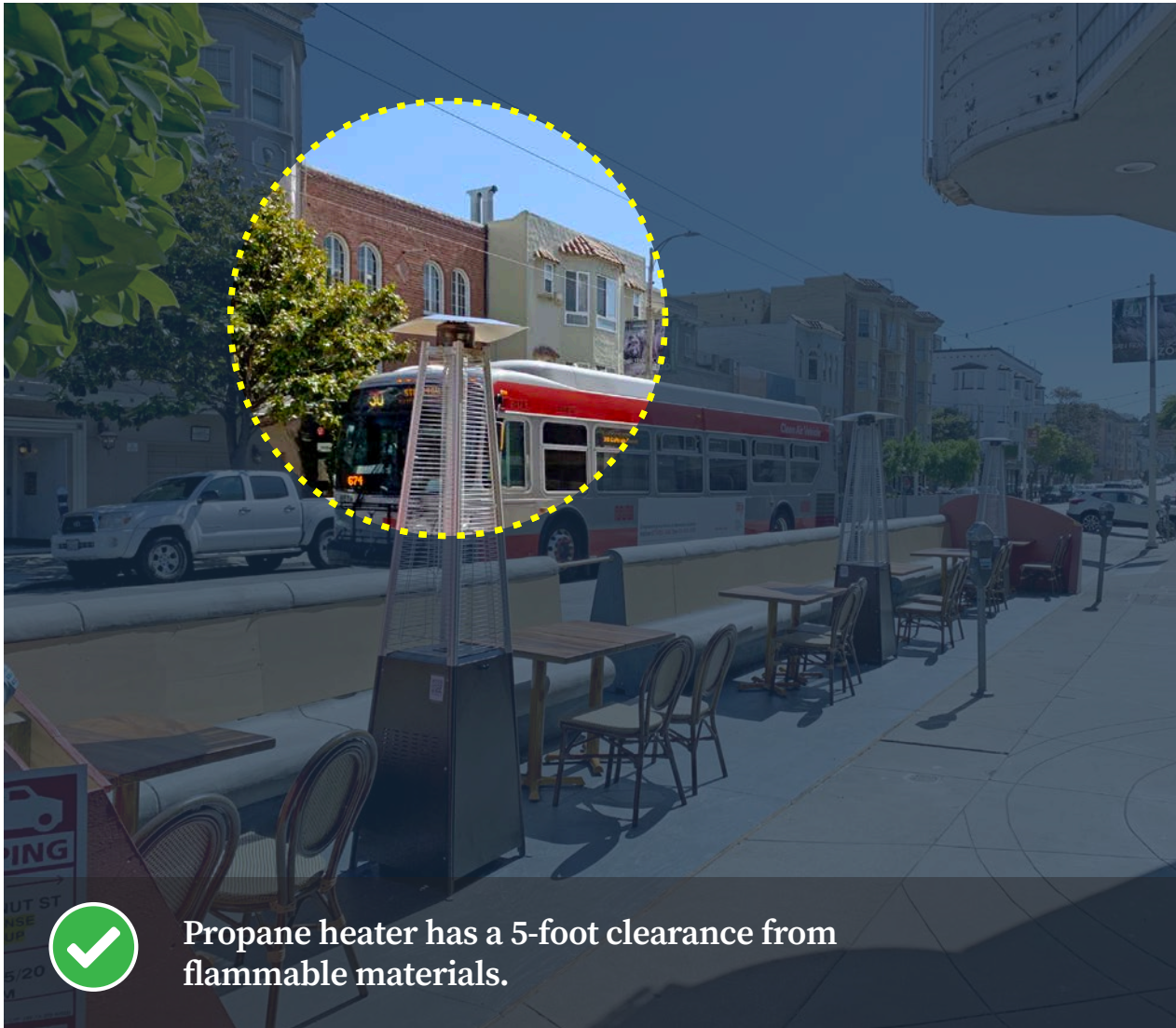

Propane heater has a 5-foot clearance from flammable materials.

ADDITIONAL REQUIREMENTS

P34 Propane heaters cannot be placed underneath overhead canopies, awnings, inside buildings or tents and they must have 5-foot clearance from any flammable materials.

P33 An SFFD Operational Permit is required for storage and use of liquid propane gas

P30 Electric heaters may be used in parklets per manufacturer's safety specifications. Contact Department of Building Inspection for exterior electrical outlet installation at building.



Propane heater placed underneath a canopy.

Electrical cords and cables

Cords or cables can be easily unplugged from outlet in an emergency.



 A single cord plugged directly into electrical outlet is easy to unplug in case of emergency.

RESTRICTIONS

P28 Power cords between the building and parklet shall be limited to one (1) cord at each end of the parklet and shall not be adjacent, above, below or attached to any part of the fire escape.

P29 All cables, cords, or wires used for lighting and speakers shall be run overhead.

P29 Cable ramps are not permitted. See Accessibility section in Appendices.

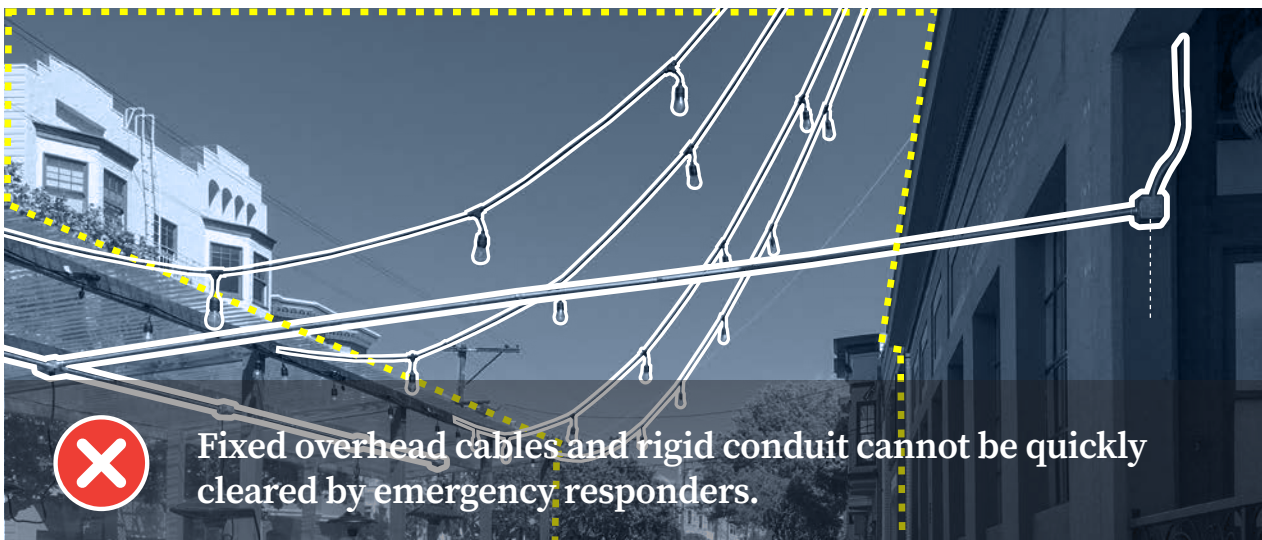

 Fixed overhead cables and rigid conduit cannot be quickly cleared by emergency responders.

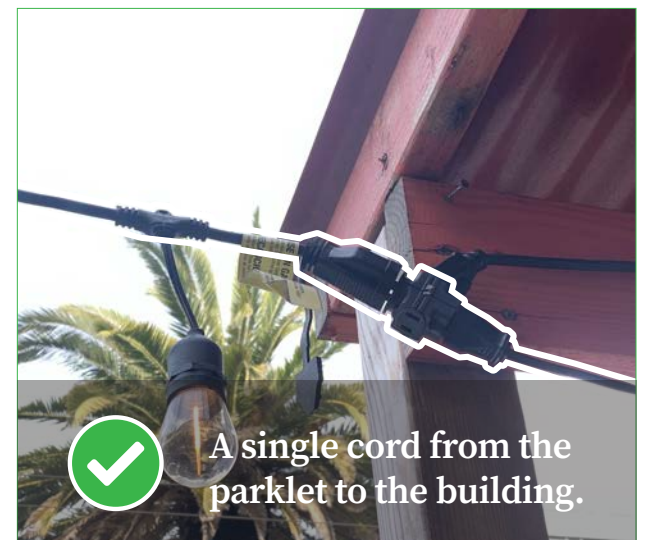

 A single cord from the parklet to the building.

Address Display

Emergency responders need to identify addresses of adjacent buildings. The building street address should be displayed on the parklet and easily read from the street.



P31 The address for each storefront or building where a parklet is located shall be displayed at a height of 36 to 42 inches on the street-facing side of the enclosure and be readily visible for emergency responders.

Address numbers shall be a minimum of 4 inches tall (5/8-inch-wide stroke) with black numbers on a white background or other high-contrasting colors.





Accessibility

Shared Spaces thrives to be fully accessible to, and useable by, all people with disabilities. All accessibility elements of the proposed structure shall be designed, constructed and/or conform to the applicable provisions, rules, regulations and guidelines of the San Francisco Building Code (SFBC) and Americans with Disabilities Act 2010 Standards accessibility requirements (ADAAG).

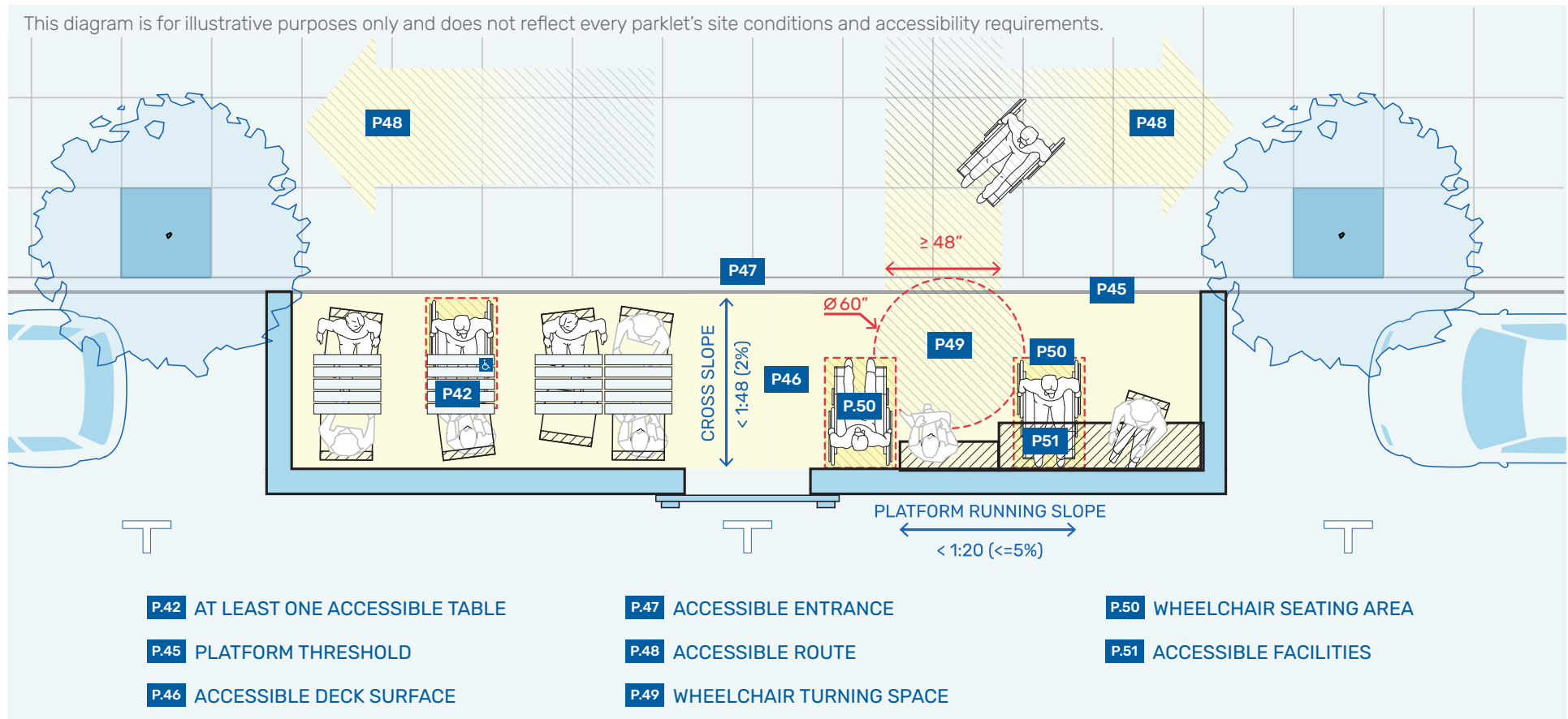

Platform Access

Persons with disabilities must be able to access parklets.

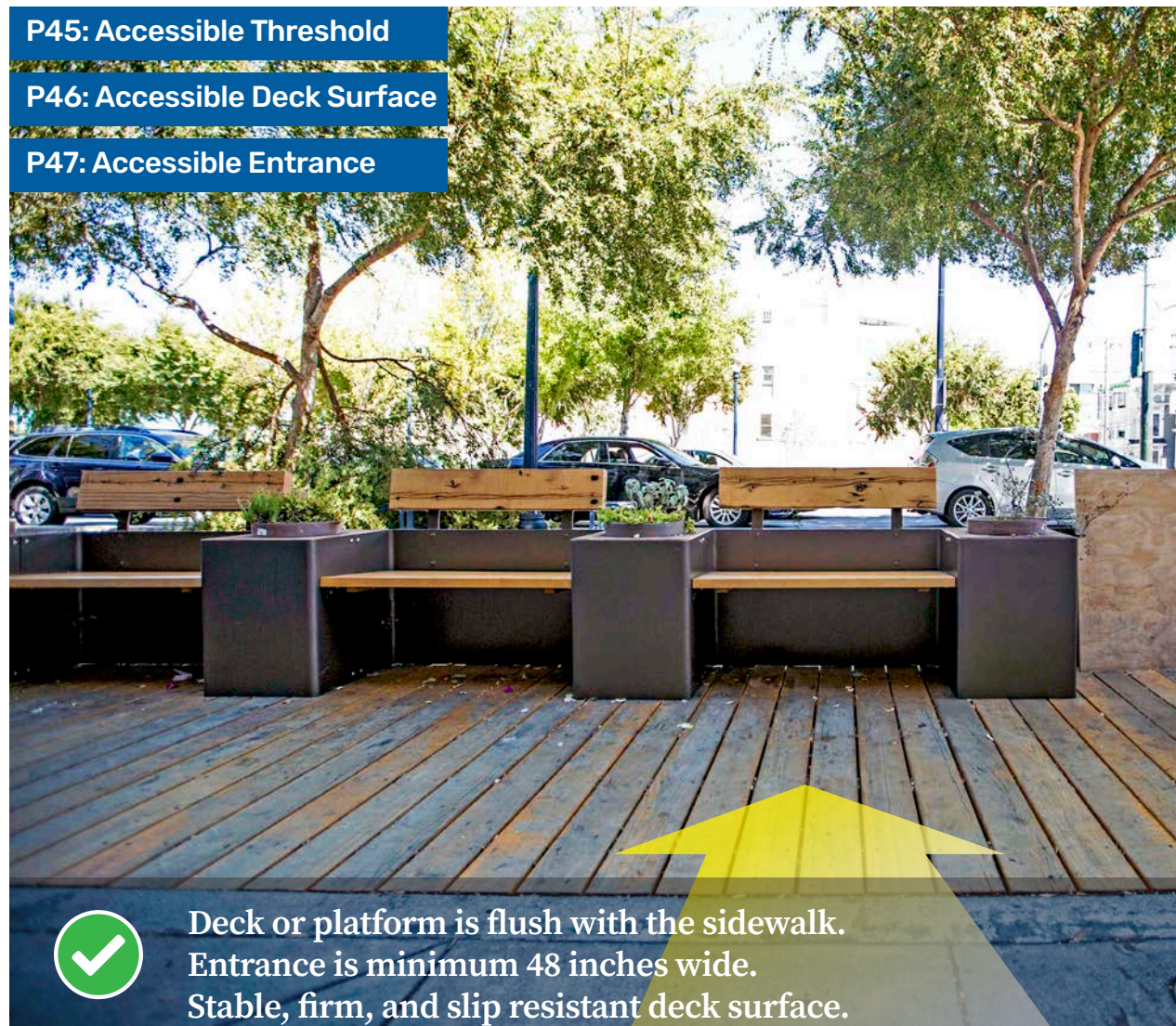

All movable commercial parklets must comply with all accessibility requirements in this Manual. Additional details on accessibility requirements are included in the Appendix. Be sure to review the supplement, particularly if your Shared Space has unique site conditions or design elements.

ADDITIONAL REQUIREMENTS

- The deck of the platform shall be flush with the sidewalk
- Entrances to parklets shall be at least 48-inches wide and not be obstructed by barriers including but not limited to parking meters, bike racks, poles, and/or other vertical obstructions
- The deck must connect the sidewalk through the accessible entrance, to the deck surface, wheelchair turning space and wheelchair seating area
- The cross-slope of platforms shall not exceed 2%.
- The running slope (slope parallel to the curb) of the platform shall match the sidewalk running slope (up to 5% maximum).

Platform Access

Persons with disabilities must be able to access parklets.



P48 All entrances to the platform are required to be flush with the sidewalk, unobstructed and accessible.

P45 Lips or thresholds should not be taller than 1/2 inch. Vertical separations between 1/4 inch and 1/2 inch high shall be beveled with a slope not steeper than 1:4 (25%)

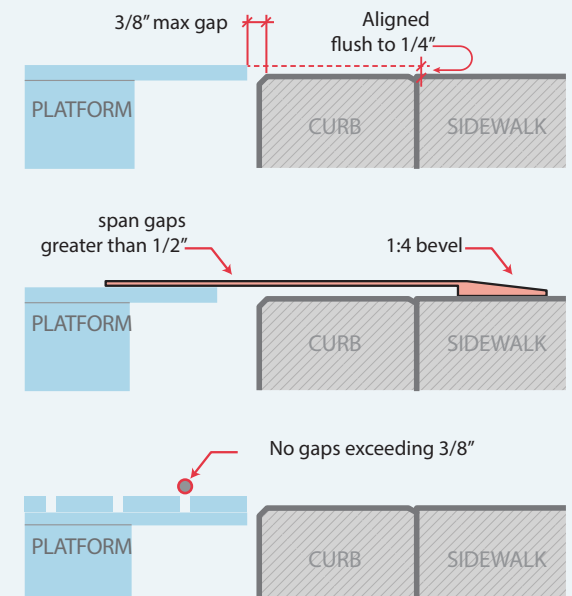

Accessible Route

All Shared Spaces must be fully accessible to, and useable by, people with disabilities.

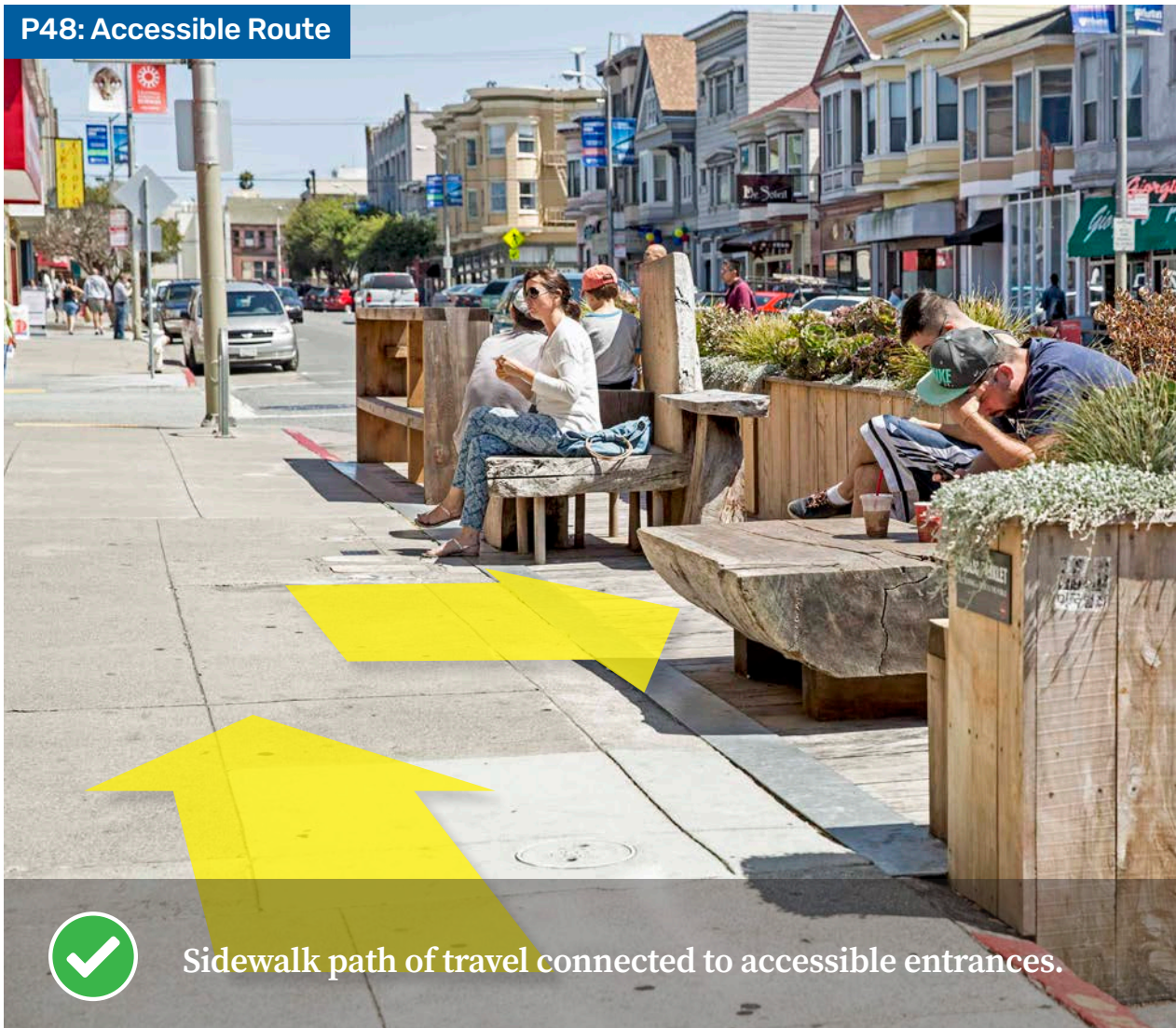

P48: Accessible Route

P48 The accessible route must connect the sidewalk through the accessible entrance, to the deck surface, wheelchair turning space and wheelchair seating area.

P28 P29 Cable ramps are not permitted.

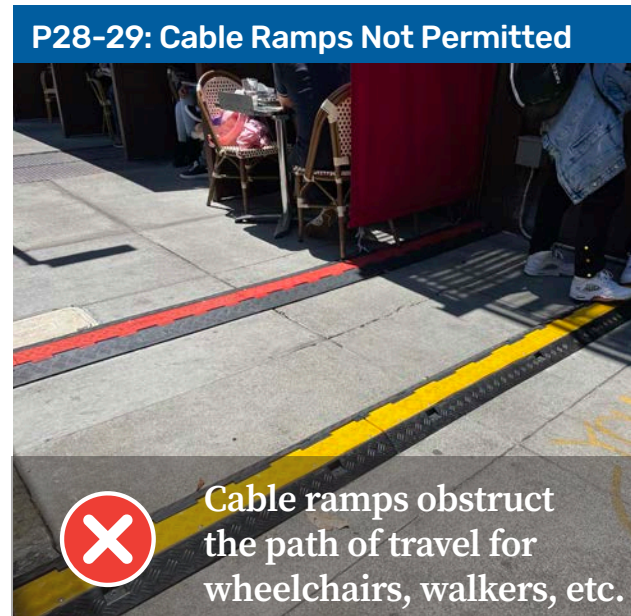

P28-29: Cable Ramps Not Permitted

Cable ramps obstruct the path of travel for wheelchairs, walkers, etc.

Wheelchairs

All Shared Spaces must be fully accessible to, and useable by, people with disabilities.

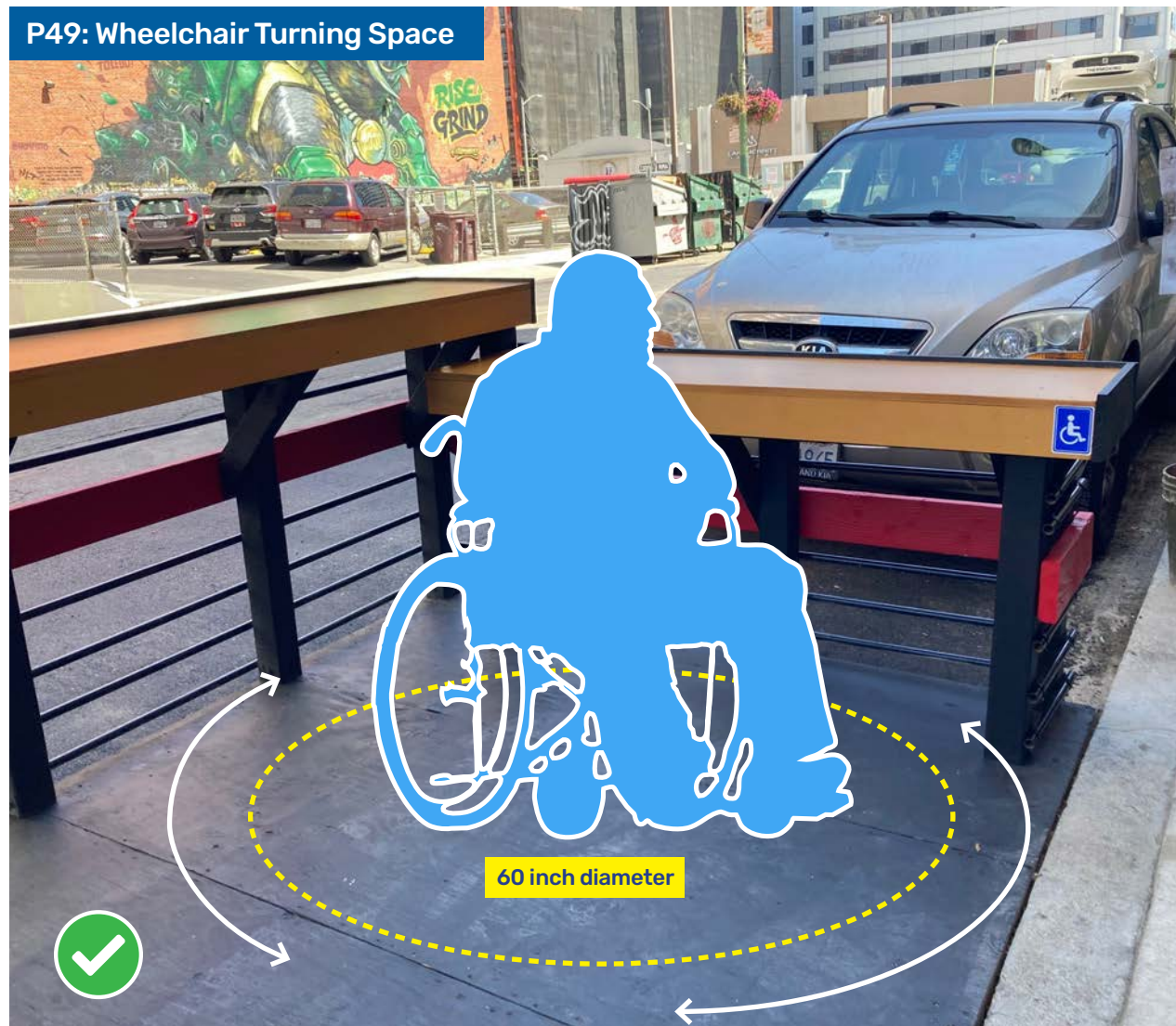

P49 Provide wheelchair turning space that is at least 60 inches in diameter and located entirely within the platform; a 12- inch maximum overlap on the curb and sidewalk is acceptable. A T-turn per California Building Code 11B is also acceptable.

P50 A 30- by 48-inch clear floor area. A minimum 4-foot maneuvering clearance is required from the front edge of wheelchair seating area to the table or counter.



Equal Access

Persons with disabilities should be able to use all amenities in your parklet.



P51: Accessible Facilities



Accessible drink rail provided.

ACCESSIBILITY SUPPLEMENT

- See Appendix for detailed diagrams of accessible furniture requirements
- Where tables, counters, or drink rails are provided, at least one of each feature shall be wheelchair accessible.

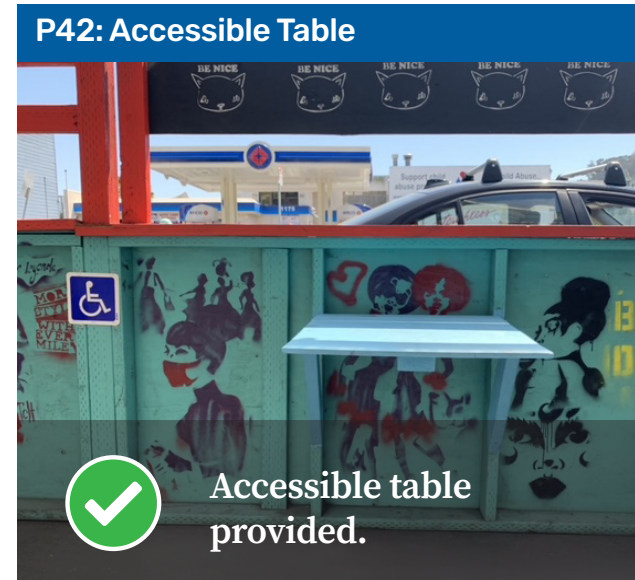

P42: Accessible Table



Accessible table provided.

R Roadway Shared Spaces



Businesses, merchant groups, and community organizations may apply for a Roadway Shared Space. This type of Shared Space is a recurring closure of traffic lane(s) that doesn't interfere or delay a public transit service, and generally do not exceed ten consecutive hours per day, over four consecutive days per week. Staff will ensure all emergency services are able to operate while the propose closure takes place.

You can ask for one or more blocks to be closed to traffic and opened for people and business. Partial closures of some traffic lanes, not the full street, may be possible in some locations.

Which activities are allowed in Roadway Shared Spaces?

- Informal gathering
- Outdoor recreation
- Entertainment and amplified sound
- Outdoor seating for cafes and restaurants
- Retail display or sales
- Services

All applications for Roadway Shared Spaces are unique and will need to be closely reviewed by staff. Streets where there is broad community support from nearby businesses and residents have a better chance of being approved.

Location Criteria

Preferred conditions on proposed street closure:

- Free of public transit or bike lanes
- No driveways or alleys
- Low traffic volumes and slow speeds
- No fire or police stations, medical facilities, or similar facilities

Design Criteria

- R1** Sidewalks shall remain open at all times for normal pedestrian use. Additional permits are needed for adding tables, chairs, or other physical objects on the sidewalk
- R2** You may not fasten any object to the surface of the street or sidewalk, nor affix to any pole without prior written consent of the Director of Public Works
- R3** An accessible route to roadway shared spaces is required, which may be provided by utilizing existing curb ramps and/or providing an accessible ramp to the roadway.

R4 Do not obstruct any manhole covers, utility covers, valve box covers, or similar infrastructure

R5 Keep furniture and all other physical objects in the approved area

R6 Keep the street clean of trash, debris, and food waste at all times

R7 Comply with other City regulations as applicable

R8 Get required permits for specific activities like serving alcohol

R9 **All Roadway Shared Spaces elements must be removed at the end of the permitted closure time, each day. No elements (barricades, furniture, etc.) shall be stored within the public right-of-way.**

See Section 3: Shared Spaces Operations for Roadway Shared Spaces Monitor Responsibilities

FIRE SAFETY & EMERGENCY ACCESS



- R10** Keep all Fire Department devices free of obstructions. You may not place objects within 15 feet of any fire hydrant or within 5 feet of any fire alarm box or police call box
- R11** Maintain an emergency access lane through the closed block(s) free of any physical objects (including signs, furniture, and art displays)

TRAFFIC SAFETY



- R12** Keep intersections, crosswalks, curb ramps, and driveways free of obstructions
- R8** All materials and equipment used for the closure shall be removed and the street returned to normal condition at the end of the permitted closure time each day.
- R14** All Roadway Shared Spaces must provide and use appropriate barriers and street signage.

ACCESSIBILITY



- R15** Applicants must provide 5% but not less than one (1) accessible table available for wheelchair users. If tables are provided in a roadway shared space, there shall be an accessible table within that roadway shared space. See *Section 5: Appendices* for details
- R16** Temporary mid-block accessible curb ramps may be required to provide an accessible route between the sidewalk and street level.
- R17** Shared spaces shall not reduce or have the effect of reducing the accessibility of the sidewalk to persons with disabilities. The Americans with Disabilities Act and 2010 Accessibility Standards (ADAS) require performance areas to be accessible to persons with disabilities.

APPLICATION CHECKLIST

See *Section 5: Appendices* for a checklist of items to prepare for the digital permit application submittal.



Types of barricades and delineators

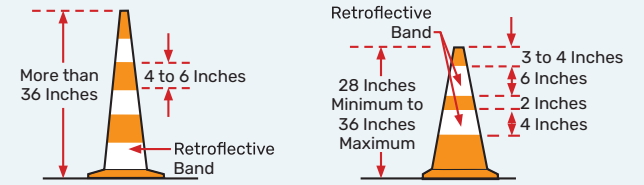
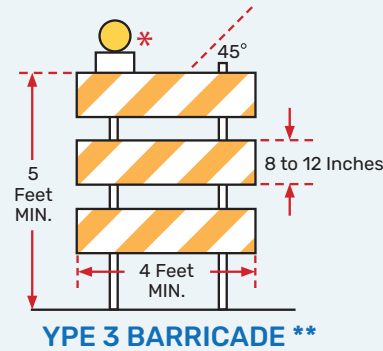
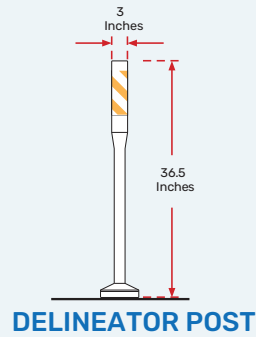
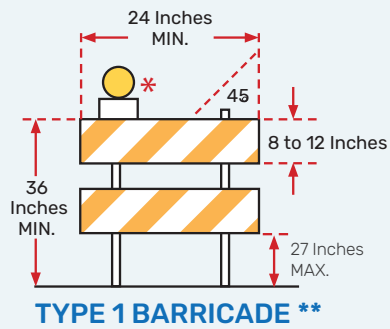

Night and/or freeway
High-speed roadway
(≥45mph)

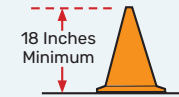

Day and low-speed
roadway (≤45mph)

* Warning lights (Optional)

** Rail stripe widths shall be 6 inches, except that 4 inch-wide stripes may be used if rail lengths



Pr Private Property Shared Spaces



You may apply for a Shared Spaces permit (expiring on 03/31/2023) for your business to use outdoor space on private property like rear yards, vacant lots, parking lots, and patios.

Permits Expiring in March 2023

As of April 1, 2023, Shared Spaces permits for private property will no longer be valid and operators will need additional approvals from outside of the Shared Spaces program for continued use of these outdoor sites.

Zoning Restrictions

Your business use must be allowed in the zoning district or special use district. If you wish to use space in a location away from your existing business, we will help you figure out if your business is allowed there.

You can find your zoning at:
sfplanning.org/resource/find-my-zoning

More information at:
sf.gov/use-private-property-your-business

APPLICATION GUIDANCE

Check *Section 5: Appendices* for additional guidance.



Photo by Shared Spaces

Outdoor Entertainment and Amplified Sound



In order to hold entertainment or amplified sound in an outdoor space, an entertainment permit is required from the SF Entertainment Commission. Here are examples of activities that require a permit:

- Live music like a band or DJ
- Theater, comedy, or dance performance
- Fashion show
- Amplified speech
- Amplified sound without a performer, like pre-recorded music or sound on a patio
- Film/TV screening with amplified sound

Get a JAM Permit

JAM or “Just Add Music” Permit (program expires on 3/31/2023): the JAM Permit program was launched in September 2020 as a temporary, free permit to help businesses hold safer outdoor arts and entertainment activity during the pandemic.

Applications will be accepted at sf.gov/jam until all JAM permits expire on March 31, 2023. Once the program expires, there will be a short wind-down period before JAM permits must stop operating. Starting January 2023, applications will become available for the One Time Outdoor Event Permit for outdoor events taking place after March 31, 2023. See permit description below.

Are you a current JAM permit holder with ongoing entertainment or amplified sound? And do you want to continue holding that activity after March 31, 2023?

If YES, you will have the opportunity to apply to transfer your existing JAM permit to a permanent brick-and-mortar permit or a temporary One Time Outdoor Event permit.

To get a permanent brick-and-mortar entertainment permit at your outdoor space

Apply for a new [Shared Spaces Legislated Permit](#). You need this approval for the outdoor space before your business is eligible to apply for a brick-and-mortar entertainment permit.

- **For use of sidewalk or parking lane,** visit: sf.gov/step-by-step/existing-shared-spaces-permittees-apply-legislated-permit
- **For use of private lot,** visit: sf.gov/use-private-property-your-business
- **To operate your Roadway Shared Space after March 2023,** you will need to submit your application online at: sf.gov/shared-spaces.

Once you receive the approval, contact the SF Entertainment Commission to start the application process to get a brick-and-mortar permit to host outdoor entertainment or amplified sound.

If you already have a brick-and-mortar permit for indoor entertainment, you may apply to amend your permit to add entertainment/amplified sound to your outdoor space.

- The Entertainment Commission’s brick-and-mortar permits are:
 - » [Limited Live Performance \(LLP\) Permit](#)
 - » [Place of Entertainment \(POE\) Permit](#)
 - » [Fixed Place Outdoor Amplified Sound \(FPAS\) Permit](#)
- An applicant’s eligibility to transfer from a JAM permit to a brick-and-mortar entertainment permit depends on the continued permissibility of the proposed use at the outdoor location through a Legislated Shared Spaces permit, Tables and Chairs permit, Parklet Permit, or Land Use Authority approval (such as Planning or The Port).
- All transfer applicants must comply with standard public noticing, neighborhood outreach, and public meeting requirements.

To get a temporary entertainment permit at your outdoor space:

One Time Outdoor Event Permit (for outdoor events taking place starting April 1, 2023). Apply for this permit to host outdoor entertainment or amplified sound activity for up to 12 days per year per location. This permit application will become available starting in January 2023 at: [SF.gov/EntertainmentCommission](https://sf.gov/EntertainmentCommission)

- The Entertainment Commission has the discretion to approve more than 13 days for one location if requested. The Commission may hold a hearing or place conditions on the permit to ensure code compliance, neighborhood compatibility, and that this permit is not being used as a substitute for getting a brick-and-mortar permit.
- One Time Outdoor Event permits with 13 or more days at one location, or other Commission-agreed upon criteria, must comply with standard public noticing, neighborhood outreach, and public meeting requirements.
- Applicant must obtain permission from the appropriate public agency or private property owner before a One Time Outdoor Event permit can be granted.



Contact the Entertainment Commission with questions:

entertainment.commission@sfgov.org,

628-652-6030.

Learn more at:

[SF.gov/EntertainmentCommission](https://sf.gov/EntertainmentCommission).





SECTION 3

Shared Spaces Operations

Photo by Shared Spaces.

Operator's Responsibilities

All Shared Spaces permit holders must abide by all terms and conditions of the Shared Spaces permit.

Accessibility

- **Clear path of travel:** Hosts are responsible for maintaining a clear path of travel, not only from furniture or structures, but also from patrons in queue or waiting.
- The permit holder shall be responsible for ensuring the space occupied and services offered under the permit comply with applicable health orders and directives, as well as with all laws requiring accessibility for people with disabilities and that the space and services do not interfere with emergency responders access.

Upkeep & Maintenance

- You are required to keep your Shared Spaces well maintained and in good repair under the conditions of approval of your permit. Shared Spaces operators sponsors are encouraged to develop a maintenance plan for keeping a Shared Spaces safe, free of trash, debris, graffiti, and to keep all elements in good condition.
- Shared Spaces operators are required to sweep the area surrounding their space and keep it litter-free
- Curbside and Parking Lane Shared Spaces must rinse out and clean debris from the area under their structure at least once a week. The Department of Public Health may require you to provide pest abatement beneath the parklet platform.
- Shared Spaces parklets that have been installed for several years will likely require renovations from time to time due to wear and tear from daily use and prolonged exposure to the elements.
- All Shared Spaces operators are responsible for providing and maintaining access to the city's infrastructures (including, but not limited to: utility poles, gas valves, manhole covers, waste water systems, fire hydrants, cisterns and catch basins). This can include the temporary or permanent removal and/or storage of any structure(s) inhibiting access to these facilities.



- Shared Spaces hosts must maintain the quiet, safety, and cleanliness of the sidewalk and parking lane space and its adjacent area, in accordance with standards set forth in the [Public Works Good Neighbor Policy](#).
- In addition, You are responsible for removing any structures when the Shared Spaces permit expires, or when you wish to end their participation in their Shared Spaces program. See *Section 4: Enforcement* for details.
- Your Shared Spaces permit must be displayed at business frontage when applicable.



Report a Shared Spaces violation. Go to sf.gov/sharedspaces, or submit a complaint to 311 at: sf311.org/services/shared-spaces-permit-violations



Hours of Operation

- **Tier 1 Fixed Public Parklet:** Must maintain public access at all times, regardless of business or entity’s hours of operation
- **Tier 3 Fixed Commercial Parklets:** Operators may reserve seating and tables within their parklet, except for the public bench, which must remain open to the public at all times, whether or not they’re patrons of the business. Commercial parklets are allowed to secure access to the structure from 12:00am to 7:00am.
- **Tier 2 Movable Parklets:** Operators may reserve seating and tables within their parklet, except for the public bench, which must remain open to the public at all times, whether or not they’re patrons of the business. Operators may choose up to three consecutive time blocks from the following available times:
 - » 8 a.m. to Noon
 - » Noon to 3 p.m.
 - » 3 p.m. to 6 p.m.
 - » 6 p.m. to 10 p.m.

All elements of the movable parklet must be removed outside of the allocated time blocks. No elements (barricades, furniture, etc.) shall be stored within the public right-of-way.
- **Roadway:** All Roadway Shared Spaces elements must be removed at the end of the permitted closure time, each day. No elements (barricades, furniture, etc.) shall be stored within the public right-of-way.
- **Private Private Lot:** Most Private Lot Shared Spaces will be ruled by their Zoning restrictions. Visit sfplanning.org for details.



Permit Renewal

- The fee to renew a Shared Spaces permit will vary by type and scope of permit. Visit sf.gov/sharedspaces to calculate your renewal fees. Read the details of your permit to prepare for renewal.
- If significant public concern is expressed about the installation or stewardship of your Shared Space, Public Works may conduct a public hearing before a Public Works Hearing Officer to determine if your permit should be renewed.



Removal

For Tier 1 & 3 Parklets

Ending your temporary Shared Space?

Go to sf.gov/end-your-shared-space for instructions.

- **Self-initiated removal.** If for some reason you decide you no longer want to keep your parklet, you are responsible for notifying Public Works and removing it at your own expense. Removal requires an additional permit from Public Works.
- **Streetscape improvements.** In some instances such as street repaving, utility work, or streetscape redesign, the City may require you to remove your parklet. The City will strive to notify you as early as possible in such instances. Circumstances permitting, you may be able to re-install your parklet after the street improvement has been completed. In such cases, you may need to store your parklet off-site during streetscape

construction. You are responsible for the costs of removing, storing, and re-installing the parklet.

- **Public safety emergencies.** Because parklets may sit atop buried utilities, there may be instances where your parklet will need to be removed with little notice. In the unlikely event of a utility failure such as a gas leak that threatens public safety, the City may remove your parklet with little or no notice. You are responsible for the cost of re-installing and restoring any damage to the parklet.
- **Failure to maintain.** Parklet operators who fail to properly and sufficiently maintain the cleanliness, safety, and accessibility of their parklet may be subject to violations and fines. If maintenance issues are not resolved, parklet operators may be required by Public Works to remove the parklet at their own expense.



Change of Ownership

If your business changes ownership, you will either need to remove your parklet or transfer the permit to the new owner. To transfer the permit, the new operator must submit a new permit through sf.gov/sharedspaces.

You retain full responsibility for the parklet until such time that the new sponsor’s permit is officially approved by Public Works. For more details on permit transfers, contact Public Works.

This page left intentionally blank



SECTION 4

Enforcement

Enforcement & Compliance for Parklets

All Shared Spaces permit holders must abide by all terms and conditions of the Shared Spaces permit.

Economic recovery from the COVID-19 pandemic will be an ongoing process in the months ahead.

To stabilize neighborhood businesses, the Shared Spaces Ordinance allows for a staggered transition from the emergency, pandemic version of Shared Spaces to the legislated version of the program.

New design and operating regulations will go into effect gradually over time. These new rules ensure disabled access, emergency response, transit function, and loading zones. This will minimize negative financial impacts for Shared Spaces parklet sponsors who need to make modifications.

Parklet sponsors will receive communications from the City to help them understand how to make their pandemic Shared Spaces safe and accessible.

Transition & Compliance Timeline at: sf.gov/shared-spaces-timeline

Definitions:

- **Pandemic Shared Spaces Program:** Emergency pandemic program with temporary permits with relaxed provisions. Ends 3/31/2023.
- **Legislated Shared Spaces Program:** Formal program with regulations which will gradually go into effect through 4/1/2023.



North Beach Merchant Walk with Shared Spaces team. Photo by Shared Spaces.



Mission Merchant Walk with Shared Spaces team. Photo by Calle 24.



Bayview Merchant Walk with Shared Spaces team. Photo by Shared Spaces.

- **Compliance Advisory via email.** This will summarize all the design and placement issues at each site that the City has noted so far. These issues will need to be corrected for the site to be eligible for a post-pandemic permit that starts April 2023.

San Francisco

Shared Spaces

sf.gov/sharedspaces

Compliance Advisory

Date Printed: 8/23/2022

Dear Shared Spaces Permit Holder:

We all recognize the impacts the pandemic shutdown had on local businesses and the challenges many are facing reopening and rebuilding. We are currently focusing enforcement efforts on life-safety and significant ADA issues. Economic recovery from the COVID-19 pandemic will be an ongoing process in the months ahead. To stabilize neighborhood businesses, the Shared Spaces Ordinance allows for a staggered transition from the emergency, pandemic version of Shared Spaces to the permanent version of the program. We are eager to provide you with as much advice as possible using the email addresses below.

Design and operating regulations will go into effect gradually over time. This will help minimize negative financial impacts for Shared Spaces sponsors who need to make modifications. These rules ensure disabled access, emergency response, transit function, and loading zones.

See below for issues that require immediate attention, as well as other issues that can wait until March 2023 should you desire to transition into the permanent program. Departments listed below may be in touch in the months ahead with additional items. You will receive separate communication regarding timelines for the items listed below.

Business: **The Blue Legume** BOS District
 1234 PARKLET ST, SAN FRANCISCO, CA, 94103 **D 03**
 Type: Parking Lane

COMPLIANCE ISSUES (BY CITY AGENCY)	SHARED SPACES MANUAL *
DPW BSM (Contact Fady Khoury, SharedSpacesPermit@sfdpw.org)	
Built Platform Structure Non ADA	P.1-P.4; P.18; P. 29
Lack Of ADA Accessible Seating	P.42
Flooding	P.15
SFFD Bureau of Fire Prevention (Contact Lt. Sy, FireSharedSpaces@sfgov.org)	
Required Gap For SFFD Access	P.19
Structure Blocks View 42 Inches	P.63; P.64; P.76
SFMTA Assessment (Contact Francesca Napolitan, SharedSpaces@sfmta.com)	
Assessment has been completed. Color Curb Issues: Yellow ; Structure has been built too wide or too long and/or is not in the space identified when the temporary permit was approved. MTA Legislated Space: Parklet Street, North side, from 173 feet to 245 feet East of 8th St at meter number(s) 555-55550, 555-55551, 555-55552 . Total 72 ft zone.	<i>Please reference SEC. 94A.3. SHARED SPACES POLICIES AND OBJECTIVES for the relevant code section for the Curb Management Strategy.</i>

*The Shared Spaces Manual is available at sf.gov/shared-spaces-manual (VERSION 1.1 11.22.2021)

To see if your business qualifies for a grant to enhance or improve your Shared Space, please visit <https://sf.gov/topics/small-business-storefronts> to see funding available now.

311 Free language assistance / 免費語言協助 / Ayuda gratis con el idioma / Бесплатная помощь переводчиков / Trợ giúp Thông dịch Miễn phí / Assistance linguistique gratuite / 無料の言語支援 / 무료 언어 지원 / Libreng tulong para sa wikang Filipino / การช่วยเหลือทางด้านการสื่อสารโดยไม่เสียค่าใช้จ่าย / 免費語言協助

- **Single Bill of Health (SBH / Enforcement & Compliance Cover Sheet)** in person or via email for the sites with the most hazardous conditions. This is like the Compliance Advisory but will include hard deadlines instead of typical deadlines. DPW and SFFD exercise discretion to advance each site to the next step of escalation, depending on responsiveness of the permittee.

It will be part of a packet that includes:

- **Notice of Correction or Notice of Violation from Public Works.** This will have strict deadlines and fees if you have not been responsive to initial communications from DPW
- **Notice of Violation from the San Francisco Fire Department.** This will have strict deadlines and fees if you have not been responsive to initial communications from SFFD

San Francisco
Shared Spaces Enforcement & Compliance Cover Sheet
sf.gov/sharedspaces

Date Printed: 8/23/2022

Dear Shared Spaces Permit Holder:

We all recognize the impacts the pandemic shutdown had on local businesses and the challenges many are facing reopening and rebuilding. We are currently focusing enforcement efforts on life-safety and significant ADA issues. Economic recovery from the COVID-19 pandemic will be an ongoing process in the months ahead. To stabilize neighborhood businesses, the Shared Spaces Ordinance allows for a staggered transition from the emergency, pandemic version of Shared Spaces to the permanent version of the program. We are eager to provide you with as much advice as possible using the email addresses below.

Design and operating regulations will go into effect gradually over time. This will help minimize negative financial impacts for Shared Spaces sponsors who need to make modifications. These rules ensure disabled access, emergency response, transit function, and loading zones.

See below for issues that require immediate attention, as well as other issues that can wait until March 2023. More detail on each issue is also included in this packet.

Business: **The Blue Legume** BOS District
 1234 PARKLET ST, SAN FRANCISCO, CA, 94103 **D 03**
 Type: Parking Lane

COMPLIANCE ISSUES (BY CITY AGENCY)	SHARED SPACES MANUAL *	DEADLINE TO FIX
DPW BSM (Contact Fady Khoury, SharedSpacesPermit@sfdpw.org)		
Built Platform Structure Non ADA	P.1-P.4; P.18; P. 29	09/07/2022
Lack Of ADA Accessible Seating	P.42	09/07/2022
Flooding	P.15	03/31/2023
SFFD Bureau of Fire Prevention (Contact Lt. Sy, FireSharedSpaces@sfgov.org)		
Required Gap For SFFD Access	P.19	09/07/2022
Structure Blocks View 42 Inches	P.63; P.64; P.76	09/07/2022

SFMTA Assessment (Contact Francesca Napolitan, SharedSpaces@sfmta.com)

Assessment has been completed.
 Color Curb Issues: Yellow
 Structure has been built to wide or too long and/or is not in the space identified when the temporary permit was approved.
 MTA Legislated Space: Parklet Street, North side, from 173 feet to 245 feet East of 8th St at meter number(s) 555-55550, 555-55551, 555-55552 . Total 72 ft zone.

*The Shared Spaces Manual is available at sf.gov/shared-spaces-manual (VERSION 1.1 11.22.2021)

To see if your business qualifies for a grant to enhance or improve your Shared Space, please visit <https://sf.gov/topics/small-business-storefronts> to see funding available now.

311 Free language assistance / 免費語言協助 / Ayuda gratis con el idioma / Бесплатная помощь переводчиков / Trợ giúp Thông dịch Miễn phí / Assistance linguistique gratuite / 無料の言語支援 / 무료 언어 지원 / Libreng tulong para sa wikang Filipino / การช่วยเหลือทางด้านการสื่อสารโดยไม่เสียค่าใช้จ่าย / 免費語言協助

This page left intentionally blank

Shared Spaces Parklet Compliance Timeline (1/2)

For existing Shared Spaces operators that wish to renew their permits for the legislated program, the Shared Spaces team will help you bring your space into compliance by providing a cover sheet indicating which issues need to be corrected, and referencing the regulations in this Manual.

**Starting
August 28, 2021**

Rules starting in this phase:

- **Design for Persons with Disabilities:** Including clear path of travel on sidewalks, sidewalk diverters, and dining table for wheelchair users.



Some parklets may need to re-size, relocate, or be removed between August 2021 and July 2022. If this is the case at your site, you will receive communications in advance, in November or December 2021:

- **Design for Emergency Responder Access:** Including 3-foot wide gaps every 20 feet and removing portions of roofs that interfere with firefighting ladders.
- **Opening Transit Boarding Areas:** Clearing Shared Spaces at transit stops where bus and train service is starting again.



**Starting
Spring 2022**

Visibility at High-Injury Intersections

Some parklets near intersections may need to re-size, relocate, or be removed.

This ensures pedestrians, bicyclists, and drivers can see each other, signage, and traffic signals. If this is the case at your site, you will receive communications in advance.

**Due
January 15, 2023**



Permit Application Deadline for legislated permits

Businesses must have a legislated permit to operate on or after April 1, 2023.

To get a legislated Shared Spaces permit, you must comply with these rules on or before April 1, 2023.

- **Neighbor Consent:** Some parklets will need written consent from their neighbors, if more than half the parking space for a parklet is in front of a neighbor.
- **Site Plan:** You will need to submit a site plan that shows that your parklet will be safe and ADA accessible.
- **Public noticing requirements:** You will need to post a 10-day public notice at and around the proposed site. You will receive the notice for posting after submitting a permit application.



Shared Spaces Parklet Compliance Timeline (2/2)

Starting
April 1, 2023



Legislated Program Begins



Pandemic Shared Spaces Program ends and the legislated Shared Spaces Program begins.

Some parklets may need to re-size, relocate, or be removed. If this is the case at your site, you will receive communications in advance, in November or December 2021.

- **Color Curb Reinstatement:** Ensures there is adequate disabled, passenger, and commercial loading on the block.
- **Maximum 2 parking spaces:** Helps as many merchants as possible have the opportunity to operate a parklet. Exceptions may be considered on a case-by-case basis

Parklets must follow these rules of the legislated program on or after April 1, 2023:

- **Public benches:** All parklets must have a seating area that is open to the public; indicated with a sign.
- **3-foot setback:** All parklet structures should be set back from the end of the marked parking space, to allow additional accessibility for emergency responders. The setback is not required where the parking space is adjacent to a red curb.

Roadway 'pop-up' Street closures will begin receiving barricades, signage, and other traffic control fixtures from the City. You will no longer need to get these items on your own.

Parklet permit fees begin assessment.

Permit Application and License Fee waivers end in March 2023. Fees will be added to the Unified License Bill for your business.

For detailed compliance timeline, visit:
sf.gov/step-by-step/shared-spaces-compliance-timeline

This page left intentionally blank



SECTION 5

Appendices

In this section you'll be able to find supplemental information and sample documents relevant to your Shared Spaces application.

1. **Applying for a Shared Spaces Permit**
2. **Application Checklist**
3. **Curbside or Parking Lane Site Plan Template**
4. **Neighboring Occupancy**
5. **Neighbor Letter of Consent**
6. **Neighborhood Outreach Samples *(Optional)***
7. **Certificate of Insurance**
8. **Shared Spaces Standards and Guidelines**
9. **Accessibility Supplement**
10. **Public Health**

1. Applying for a Shared Spaces Permit

Apply for a Shared Spaces Permit Online

Requirements will vary depending on what type of space you're looking to implement and where. Step-by-step instructions to apply to the Shared Spaces program can be found at our website.

When you have all your necessary documents ready, apply at: sf.gov/sharedspaces



APPLICATION CHECKLIST



See the Application Checklists in this section to prepare for the digital permit application submittal.

Permit Approval Process

Sidewalk, Parking Lane, and Private Lot

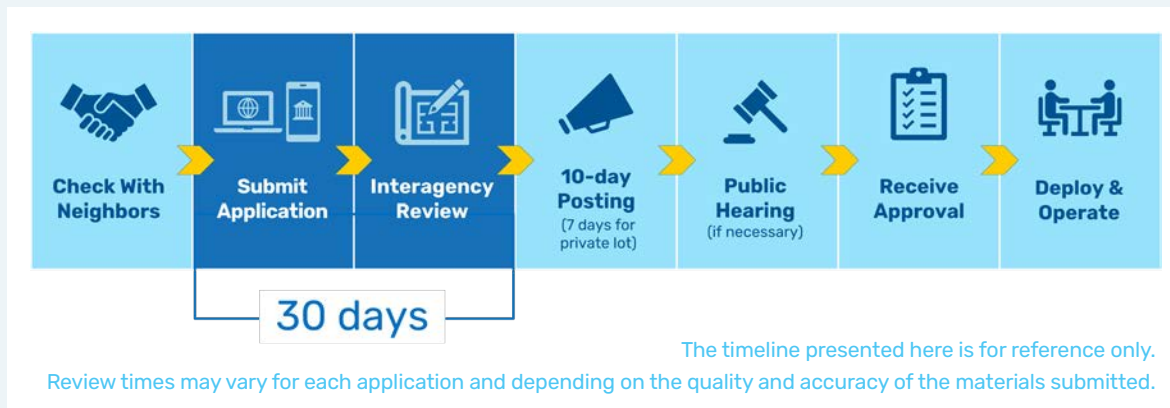

Roadway

	First 24 months of activation			After 24 months
Frequency of Recurrence at that location	≤ 4 days per week and ≤ 10 hours per day		> 4 days per week OR > 10 hours per day	Regardless of Frequency
Transit	No Transit Impact	Transit Delay	Regardless of Potential Impact	
Approval Body	ISCOTT	ISCOTT	MTA Board Consent Calendar	MTA Board Regular Calendar
Approval Timetable	≤ 30 days	> 30 days	> 30 days	~ 10 weeks

The timeline presented here is for reference only.

Review times may vary for each application and depending on the quality and accuracy of the materials submitted.

How much does a Shared Spaces permit cost?

Sidewalk fees are waived until April 15, 2023. Permit fees for Curbside and Parking Lane are waived until March 31, 2023. License fees waived for the first two years for existing permit holders.

Fees are adjusted every year.

Tables for reference only. For the most updated fee schedule, go to sf.gov/sharedspaces.

To estimate your Shared Spaces fees, go to: sf.gov/estimate-your-shared-space-permit-fees

Special Events Street Closure

Application Received	Jul 1, 2022 – Jun 30, 2023 Fee	Jul 1, 2023 – Jun 30, 2024 Fee
120+ days before event	\$1150	\$1200
90-120 days before event**	\$1400	\$1500
60-89 days before event	\$1700	\$1800
30-59 days before event	\$2100	\$2200

More information:

www.sfmta.com/committees/interdepartmental-staff-committee-traffic-and-transportation-iscott

Sidewalk Tables & Chairs

Fee (Annual)	Description
\$151	and \$8.50/SqFt (new)
\$75	and \$7.25/SqFt (renewals)
\$151	and \$9.75/SqFt (w/ departmental action)

Display Merchandise

Fee (Annual)	Description
\$163	and \$11/SqFt

Parking Lane and Curbside Fees

TIER	TYPE	OCCUPANCY FEES			ENTERTAINMENT FEES	
		Permit (one time)	Annual License	Permit Application (one-time)	License Renewal	
1	Public Parklet	\$1,000	\$250	\$100	\$532	\$211
2	Movable Commercial Parklet	\$2,000	\$1,000	\$1,500	\$532	\$211
3	Commercial Parklet	\$3,000	\$1,500	\$2,000	\$532	\$211
		First Parking Space	Each Additional Parking Space	Per Parking Space	Per Site	
1/2 fee waiver for businesses with ≤ \$2M in SF gross receipts						

2. Application Checklist

Prepare Your Application Documents

You will need to gather the following materials before applying for

Sidewalk or Curbside Shared Spaces

1. Your contact information: Name, Email, Phone Number
2. About your space:
Do you have a pandemic Shared Space permit?
 Yes No

Do you want to operate your Shared Space after April 1st, 2023?
 Yes, I want to operate my Shared Space after April 1st, 2023
 No, I want to operate my Shared Space only through March 31st, 2022
3. Type of Shared Space you would like to apply for:
 Sidewalk – tables and chairs, display merchandise
 Parking lane – public parklet, fixed commercial parklet, movable commercial parklet

If applying for a parking lane permit, you will need to know your curb color:
 green yellow white no color
4. Your **Business Account Number (BAN)** [look it up here](#) and **Address of Business Account Number**
5. Proposed **Shared Space Site Address**: Project Address (and/or Block and Lot number for your address (block and lot will auto populate after adding project address))
6. Primary Business Activity (*Check all that apply*)
 - Restaurant with alcohol sales
 - Restaurant without alcohol sales
 - Retail Store (like clothing or books)
 - Health studio or gym
 - Laundromat
 - Brewery
 - Jewelry maker
 - Bar
 - Entertainment
 - Personal service (like hair or nails)
 - Animal hospital
 - Chair or foot massage
 - Financial service
 - Grocery
 - Retail professional service
 - Trade shop
 - Food or drink manufacturing
 - Movie theater
 - Public facility
 - Institutional use (like childcare, school, or religious institution)
 - Arts activities
 - Car or automotive repair
 - Design profession
 - Catering
 - Kennel
 - Cat boarding
 - Nonprofit

7. Your **gross revenue** from your most recent tax return (numeric value)
8. Does this business location have an outdoor space other than a Shared Space?
 - Yes No
9. Does your business have 11 or more locations worldwide?
 - Yes No
10. Will you be serving alcohol?
 - Yes No
11. Will you be serve or provide food?
 - Yes No
12. Will you have amplified sound? *includes TVs with sound, live music and any amplified sound
 - Yes No
13. Tell us your business hours: Day, Opens At, Closes At (for each day your business is open)

14. Information about your proposed parking lane

- Does it have parking meters? If yes, number of parking spaces (2 spaces maximum)
- Is the parking space marked or unmarked?
- Tell us more about how your parking lane will be used (short answer)
- Does it have a bike path or is it next to a driveway, other unusual features?
- If sidewalk permit, how many linear square feet of sidewalk for your shared space?

15. Permit Holder Information

Only one permit holder per site. Your co-operators are only for informational purposes. As the permit holder, you will have all the legal liability and responsibility for the space use and permit obligations.

If you will have co-operators: Other name of business sharing the space, contact person, phone number, email address (short answer)

16. Neighboring Consent

For sidewalk use, you must get your neighbor's permission to use any of the sidewalk in front of them.

For parking lane use, you must get your neighbor's permission if more than half of marked parking space is not in front of your storefront. You must get their permission if any of an unmarked parking space is not in front of your storefront.

Will you use a neighboring space?

- Yes No

If you will be using a neighboring space: Neighbors name, neighbor's phone number, neighbor's email **AND get them to sign our Neighbor Permission form.**

Download the [Shared Spaces Neighboring Letter of Consent PDF](#). On the permit application, you will also tell us their name, email, and phone number.

Fill out the details and sign the form. You and your neighbor must sign the form.

17. Optional Demographic Information

- Do any of these describe your business, check all that apply: Minority owned, immigrant owned, woman owned, LGBTQ owned, veteran owned, owned by a person with a disability, legacy business, serving specific ethnic or cultural clientele
- Business Owners gender identity: Male, female, trans male, trans female, genderqueer, or gender non-binary, other, I prefer not to answer
- Do any business owners identify as transgender, non-binary, or gender nonconforming?
- What is your preferred language? English, Espanol, Chinese, Filipino, Other

18. Photos of your site

FOR EXISTING PARKLETS:

- **Sidewalk views**
 - 6-foot clear path of travel on the sidewalk
 - Deck threshold level with the sidewalk
 - Setbacks from an intersection: 20 feet for oncoming traffic and 8 feet from exiting traffic
- **Parklet structure**
 - Width of the entire parklet from outer edge of structure or barriers to the curb face
 - 3-foot setback on both ends of the parklet from the end of the parking space
 - 3-foot access gap that is open to the sky every 20 feet. If your parklet has more than 1 gap, take pictures of each one.
 - A picture showing visibility and airflow about 42 inches high

○ Parklet details

- Displayed street address
- 6-inch-by-6-inch clear gutter
- Reflective materials on corners of parklet from the street to the top of structure
- Accessible table or facility in the parklet
- Flexible delineator posts and wheel stops in the correct position

Label your pictures with names with what they show. You will upload them when you apply.

FOR SIDEWALK PERMITS AND ALL NEW PERMITS

○ Take 5 pictures that show:

- 3 street views (from the right, front, and left)
- 2 sidewalk views (from the right and left)

Label your pictures with names with what they show. You will upload them when you apply.

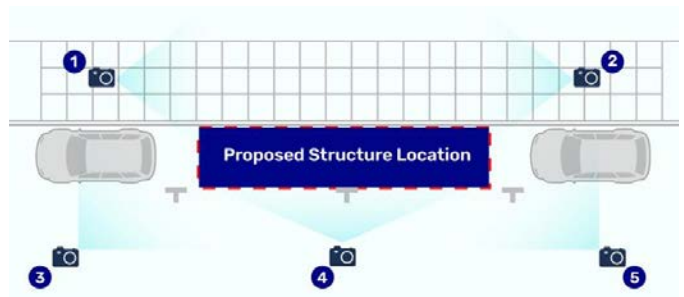

19. Certificate of Insurance (COI).

- [See our example here](#)

20. Site Plan (PDF)

- [You must use our template here](#)

This page left intentionally blank

You will need to gather the following materials before applying for

Roadway Closures

1. Your contact information: Name, Organization Name, Email, Phone Number
2. Your **Business Account Number** (BAN) look it up here (If applicable)
3. **Proposed Location:** Street, Cross Street, Other impacted locations, other details about your proposed location
4. Earliest Date of your event
5. End Date of your event
6. Days and hours of your proposed street closure
7. Business activities during your event:
 - Restaurant with alcohol sales
 - Restaurant without alcohol sales
 - Retail Store (like clothing or books)
 - Health studio or gym
 - Laundromat
 - Brewery
 - Jewelry maker
 - Bar
 - Entertainment
 - Personal service (like hair or nails)
 - Animal hospital
 - Chair or foot massage
 - Financial service
 - Grocery
 - Retail professional service
 - Trade shop
 - Food or drink manufacturing
 - Movie theater
 - Public facility
 - Institutional use (like childcare, school, or religious institution)
 - Arts activities
 - Car or automotive repair
 - Design profession
 - Catering
 - Kennel
 - Cat boarding
 - Nonprofit
8. Describe the activities you want to do at your event
9. Describe the furniture, equipment, and/or physical objects you want to use in the street space
10. Describe your proposed layout for these activities: placement of barricades, tables, chairs, booths, stages and other large items
11. Do you want to serve alcohol in the street space?
 - Yes, I want to serve alcohol in the street space
 - No
12. Optional demographic information: race, ethnicity, cultural affiliation or nationality, preferred language, gender identity
13. Uploads:
 - PDF of Site Plan,
 - Documentation of Neighborhood Support,
 - Picture of Proposed Location

This page left intentionally blank

Private Lots

As of April 1, 2023, [Shared Spaces permits for private property](#) will no longer be valid and operators will need additional approvals from outside of the Shared Spaces program for continued use of these outdoor sites.

Many existing Shared Spaces private property locations will be able to establish the outdoor use permanently by adding an *Outdoor Activity Area* use. Depending on your location, this *Outdoor Activity Area* use can be added with a Building Permit. Otherwise, it may require a [Conditional Use Authorization](#).

To identify which forms you need to submit for the specific permits you need for your business (including land use authorization), please follow this [step-by-step process](#). After you submit [this online](#)

[form](#), the Planning Department will email you all the forms you need to fill out for your proposed uses. Please describe clearly in your form submission that you have a temporary Shared Spaces private property permit that you would like to transition to a permanent *Outdoor Activity Area* land use authorization. If you need help filling out this form, the [Office of Small Business](#) may be able to provide direct assistance.

You may also visit the [Planning Information Counter](#) at the Permit Center at 49 South Van Ness Avenue, or email PIC@sfgov.org, to ask how you can make your outdoor space permanent. If you have any additional questions about the transition of Shared Spaces private property permits, please contact sharedspaces@sfgov.org.

This page left intentionally blank

3. Curbside or Parking Lane Site Plan Template

Draw an outline of your proposed Shared Space in the parking lane. We require only a basic outline showing the dimensions and location of your proposed or existing Shared Space. Site plans must be drawn to scale. The initial site plan may be hand drawn using a ruler, as long as it is clean and legible and includes all the elements listed below. Follow these instructions to complete your Shared Spaces outline:

1. Show your business and business frontage, including the sidewalk and street fronting the business.
2. Draw the shape of your proposed Shared Space, and dimension the length and width.
3. Draw a North Arrow on your site plan, showing the orientation of the plan.
4. If there are any sidewalk or roadway obstructions, like parking meters, bike racks, trees, or utilities, list them on your plan.
5. If your proposed Shared Space will encroach at all past your property line, show any adjacent business(es) and their frontage(s) on your site plan.

FIGURE A SAMPLE SITE PLAN

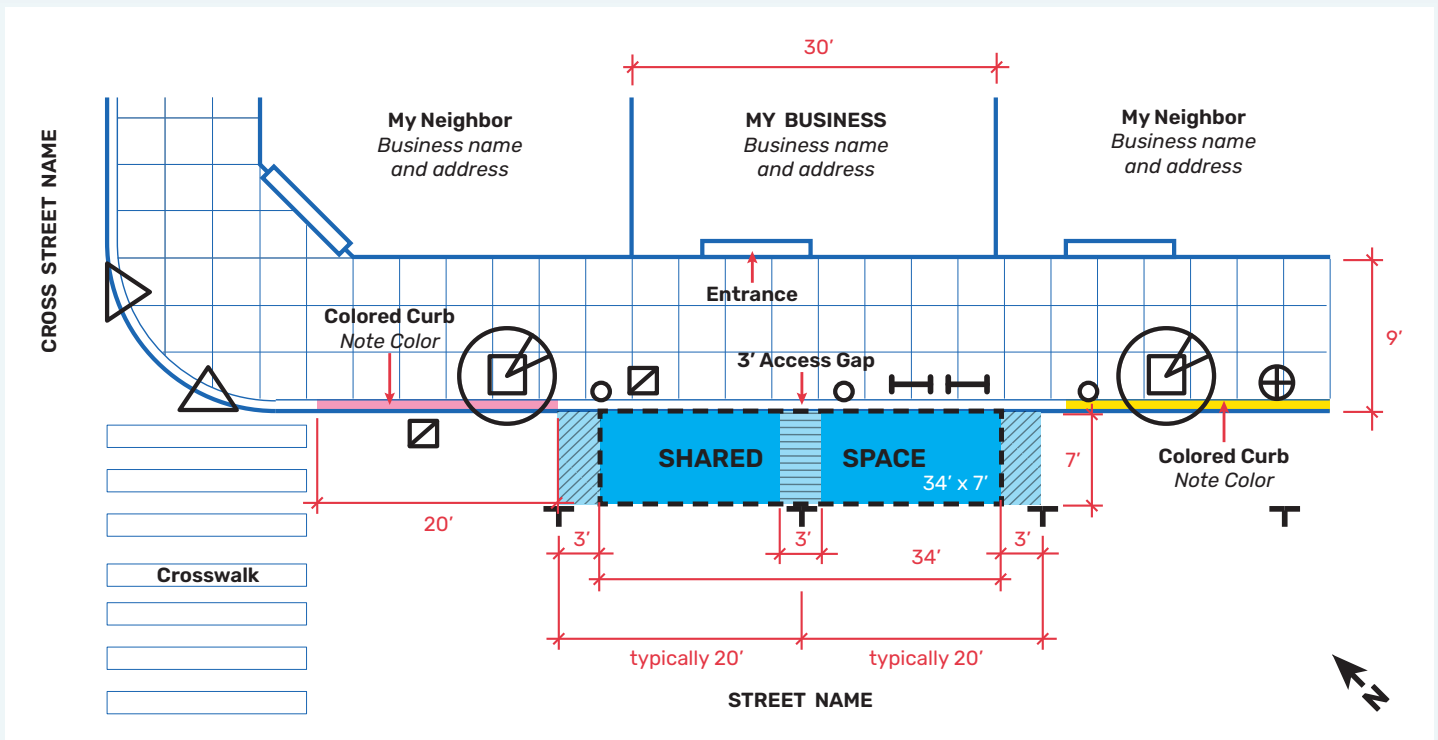

Existing Parking Meter	Existing Parking Space Marking	Existing Street Tree	Existing Curb Ramp	3 ft. Required Setback <i>do not include in shared space dimensions</i>
Existing Bicycle Rack	Existing Utility on sidewalks and streets	Existing Street Light	North Arrow	3 ft. Emergency Access Gap

This page left intentionally blank

4. Neighboring Occupancy

For parking lane use, you must get your neighbor's permission if more than half of marked parking space is not in front of your storefront. You must get their permission if any of an unmarked parking space is not in front of your storefront.

For sidewalk use, you must get your neighbor's permission to use any of the sidewalk in front of them.

More information and Letter of Consent at: sf.gov/get-permission-your-neighbors-use-their-space

OPTION 1: Shared Space fully within business frontage.

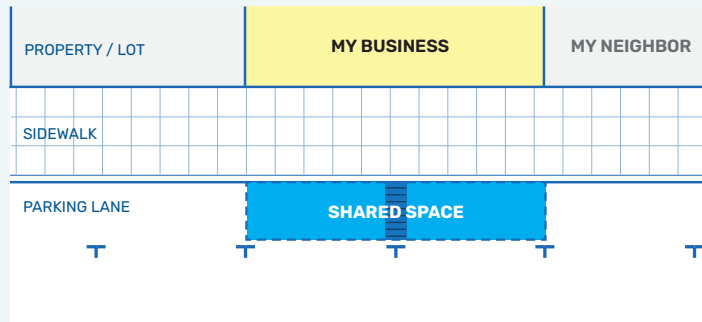

OPTION 2: Shared Space extends into a neighboring frontage, occupying an unmarked space.

NEEDS NEIGHBORING CONSENT

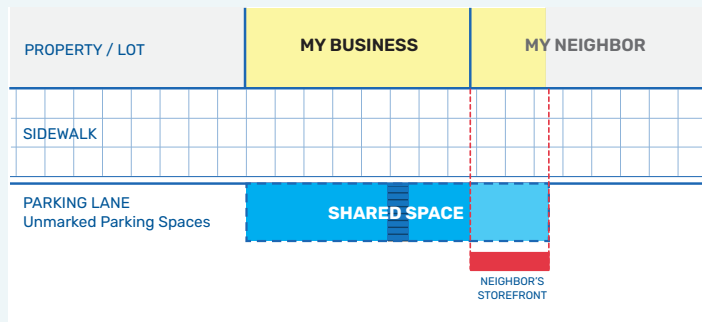

OPTION 3A: Shared Space extends only slightly into a neighboring frontage, taking up less than half of a marked parking space in the neighboring frontage.

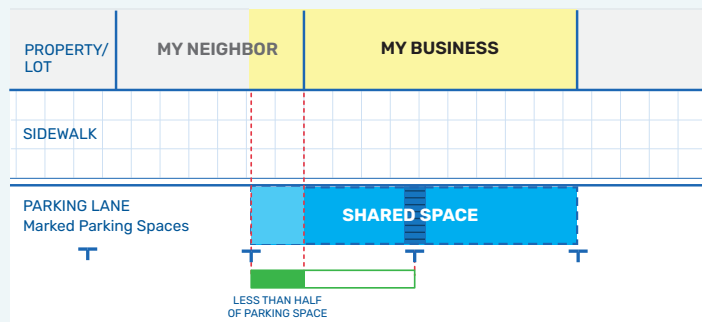

OPTION 3B: Shared Space extends at least half of one marked parking space into a neighboring frontage.

NEEDS NEIGHBORING CONSENT

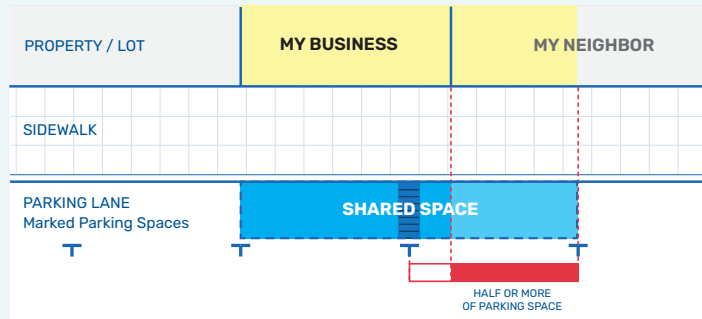

This page left intentionally blank

5. Neighbor Letter of Consent

I acknowledge that I am an owner or authorized representative of the business:

Initial:

(Insert Business Name)

located at:

(Insert Business Address)

I am seeking authorization to occupy the area associated with my Shared Spaces permit. The proposed permit extends into the frontage of a neighboring property located at:

(Insert Neighboring Property Address)

I acknowledge that, if approved, I am responsible for maintaining the full scope of my occupancy under my Shared Spaces Permit, including any permitted space that extends to a neighboring frontage, in accordance with the program terms outlined in Administrative Code Chapter 94A, Public Works Code Section 793, and corresponding Public Works Director's Orders.

Initial:

I understand that if the tenancy and/or property ownership of the neighboring property changes, Public Works may require me to submit an updated consent letter to continue utilizing any space extending into a neighboring frontage regardless of the status of my Shared Spaces permit at the time of change of ownership.

Initial:

I understand that consent to occupy neighboring space as part of my Shared Spaces permit is revocable in nature; and, if such consent is revoked, or if my occupancy is not accordance with the terms of Administrative Code Chapter 94A, Public Works Code Section 793, and corresponding Public Works Director's Orders, that my business is responsible for the removal of any structure placed in the right of way under my Shared Spaces permit, including any applicable portion of my Shared Spaces permit extending into a neighboring frontage. I acknowledge that I must obtain an up-to-date consent letter for any future permit renewals as requested by Public Works during future permit renewal processes.

Initial:

APPLICANT SIGNATURE

Signature:	Print Name:	Date:



Please email this signed letter to SharedSpacesPermit@sfdpw.org

Neighboring Acknowledgement (to be filled out by the Neighboring Tenant or Property Owner)

I acknowledge that I am the *(check one)* **ground floor tenant** **property owner** of

Initial:

(Insert Neighboring Property Address)

This property is adjacent to the business operated by the Shared Spaces Applicant.

I **consent** to allow the Shared Spaces Applicant, located at the business address listed in the above "Applicant Acknowledgement" section, to occupy the space in the sidewalk and/or parking lane fronting my leased space or property. I understand that the Shared Spaces Applicant's occupancy will be consistent with a Shared Spaces permit in accordance with the program terms outlined in Administrative Code Chapter 94A, Public Works Code Section 793, and corresponding Public Works Director's Orders.

Initial:

TENANTS ONLY

I **acknowledge** that I am not prohibited by any lease or rental agreement from granting this consent to this neighboring business.

Initial:

This consent is for the permittee's upcoming permit cycle, which may last up to 12 months from the date of permit approval and acknowledge that any enforcement action against a permittee for revoked neighbor consent may be suspended until the time of Shared Spaces permit expiration.

Initial:

TENANT OR PROPERTY OWNER SIGNATURE

Signature:	Print Name:	Date:
Title (Example: Business Owner, Property Owner)		

Please email this signed letter to SharedSpacesPermit@sfdpw.org

① 311 Free language assistance / 免費語言協助 / Ayuda gratis con el idioma / Бесплатная помощь переводчиков / Trợ giúp Thông dịch Miễn phí / Assistance linguistique gratuite / 無料の言語支援 / 무료 언어 지원 / Libreng tulong para sa wikang Filipino / การช่วยเหลือทางด้านภาษาโดยไม่เสียค่าใช้จ่าย / مساعدة لسانی مجانية بدون رسوم إضافية

6. Neighborhood Outreach Samples (Optional)

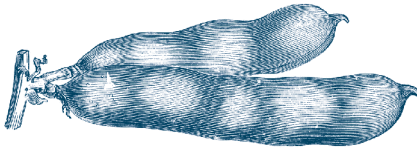

The Blue Legume

1234 Parklet Street, San Francisco

I support a parklet in front of The Blue Legume...!
Thank you for helping improve public space on Parklet Street.

**I live
within 5
blocks of
The Blue
Legume**

Signature	Name	Address	Phone #	Email	I live within 5 blocks of The Blue Legume

SAMPLE

This page left intentionally blank



Easy Street Merchants Association

To whom it may concern,

I'm writing to express my support for a parklet to be constructed in front of *The Blue Legume* located at 1234 Easy Street. I understand that the parklet would take the space of 2 parking spots. This parklet will be a great asset to the neighborhood in addition to being a space for patrons of Easy Street businesses to congregate without blocking the sidewalks or venturing into the street.

Sincerely,

(Signature)

Date

Name (printed)

Contact phone number or email

Address

This page left intentionally blank

7. Certificate of Insurance Sample

- You must have enough insurance for this program.
- You must prove you have liability insurance and workers compensation insurance. Your policies must meet these requirements.
- You must have and keep commercial general liability insurance with at least \$1 million in coverage per Occurrence and \$2 million aggregate. It must include the City and County of San Francisco, Its Officers, Employees, and Agents as additional insured or a blanket endorsement.
- You must have and keep workers compensation insurance in statutory amounts with at least \$1 million in Employer's Liability insurance coverage and a waiver of subrogation. It must include a blanket waiver or one in favor of the City and County of San Francisco, Its Officers, Employees, and Agents.

See example of Certificate of Insurance (COI) form at: sf.gov/step-by-step/get-shared-spaces-permit-your-sidewalk-or-parking-lane

ACORD.		CERTIFICATE OF INSURANCE					ISSUE DATE:	
PRODUCER:			THIS CERTIFICATE IS ISSUED AS A MATTER OF INFORMATION ONLY AND CONFERS NO RIGHTS UPON THE CERTIFICATE HOLDER. THIS CERTIFICATE DOES NOT AMEND, EXTEND OR ALTER OTHER COVERAGE AFFORDED BY THE POLICIES BELOW.					
			COMPANIES AFFORDING COVERAGE					
			COMPANY LETTER A					
			COMPANY LETTER B					
INSURED:			COMPANY LETTER C					
			COMPANY LETTER D					
COVERAGES AND LIMITS								
THIS IS TO CERTIFY THAT THE POLICIES OF INSURANCE LISTED BELOW HAVE BEEN ISSUED TO THE INSURED NAMED ABOVE FOR THE POLICY PERIOD INDICATED. NOTWITHSTANDING ANY REQUIREMENT, TERM OR CONDITION OF ANY CONTRACT OR OTHER DOCUMENT WITH RESPECT TO WHICH THIS CERTIFICATE MAY BE ISSUED OR MAY PERTAIN, THE INSURANCE AFFORDED BY THE POLICIES DESCRIBED HEREIN IS SUBJECT TO ALL THE TERMS, EXCLUSIONS AND CONDITIONS OF SUCH POLICIES. LIMITS SHOWN MAY HAVE BEEN REDUCED BY PAID CLAIMS.								
CO. LTR	TYPE OF INSURANCE	ADDL INSD	SUBR WVD	POLICY NUMBER	POLICY EFF. DATE	POLICY EXP. DATE	DESCRIPTION	LIMITS
	GENERAL LIABILITY <input checked="" type="checkbox"/> COMM. GENERAL LIAB. <input type="checkbox"/> CLAIMS MADE <input checked="" type="checkbox"/> OCCURRENCE <input type="checkbox"/> OWNER'S & CONTRACT'S PROT	Y					GENERAL AGGREGATE PROD-COMP/OP AGG PERS & ADV. INJURY EACH OCCURRENCE FIRE DAMAGE (One Fire) MEDICAL EXPENSE (One Per)	\$2,000,000 \$1,000,000 \$1,000,000 \$1,000,000 \$ 100,000 \$ 5,000
	AUTOMOBILE LIABILITY <input type="checkbox"/> ANY AUTO <input type="checkbox"/> ALL OWNED AUTOS <input type="checkbox"/> SCHEDULED AUTOS <input type="checkbox"/> HIRED AUTOS <input type="checkbox"/> NON -OWNED AUTOS <input type="checkbox"/> GARAGE LIABILITY						COMBINED SINGLE LIMIT BODILY INJURY (Per Person) BODILY INJURY (Per Accident) PROPERTY DAMAGE	\$ \$ \$ \$
	EXCESS LIABILITY <input type="checkbox"/> UMBRELLA FORM <input type="checkbox"/> OTHER THAN UMBRELLA FORM						EACH OCCURRENCE AGGREGATE	\$ \$
	WORKERS' COMPENSATION AND EMPLOYER'S LIABILITY THE PROPRIETOR/PARTNERS/EXECUTIVE OFFICERS ARE: <input type="checkbox"/> INCL <input type="checkbox"/> EXCL.	N/A	Y				<input checked="" type="checkbox"/> STATUTORY LIMITS EACH ACCIDENT DISEASE-POLICY LIMIT DISEASE-EACH EMPLOYEE	\$1,000,000 \$1,000,000 \$1,000,000
	OTHER INSURANCE							
DESCRIPTION OF OPERATIONS/LOCATIONS/VEHICLES/SPECIAL ITEMS:								
Above policies have been endorsed to name as additional insured: City and County of San Francisco, Its Officers, Employees and Agents. Worker's Compensation includes a Waiver of Subrogation in favor of the City & County of San Francisco, Its Officers, Employees and Agents.								
NAME AND ADDRESS OF CERTIFICATE HOLDER:					CANCELLATION:			
Bureau of Street-Use & Mapping 49 South Van Ness Avenue, Suite 300 San Francisco, CA 94103					SHOULD ANY OF THE ABOVE DESCRIBED POLICIES BE CANCELED BEFORE THE EXPIRATION DATE THEREOF, THE ISSUING COMPANY WILL ENDEAVOR TO MAIL <u>30</u> DAYS WRITTEN NOTICE TO THE CERTIFICATE HOLDER NAMED TO THE LEFT.			
ACORD 25-6 (3/93)					AUTHORIZED REPRESENTATIVE:			
					©ACORD CORPORATION 1993			

This page left intentionally blank

8. Design Guidelines and Regulations

S

SIDEWALK



Where can I place my Sidewalk Shared Space?

You may occupy the sidewalk space fronting your business, organization, or residence to display merchandise, place tables and chairs, public seating, or other amenities. Amenities other than tables and chairs or display merchandise will be reviewed on a case-by-case basis.

You will need your neighbor's permission if you want to occupy their frontage as well.

- Check the diagrams in this section to ensure your proposed space is feasible.
- Diverters, furnishings and fixtures for commercial purposes must be removed at the end of business hours.
- Sidewalk Shared Spaces may only be placed on the sidewalk area adjacent to the building, at the property line. Proposals for different placement will be reviewed on a case-by-case basis.
- You must get your neighbor's permission to use any of the sidewalk in front of them. See sample on *Appendices Subsection 4: Neighboring Occupancy*.

S1 Emergency Access. At no time can sidewalk occupancy obstruct emergency facilities (including, but not limited to fire hydrants, Fire Department connections, street alarm boxes, fire escapes, etc.)

S2 Heaters. LPG heaters are not permitted on the sidewalk in the pedestrian path of travel.

- » Any use of a portable heater, portable generator, candles, open flame or any activity regulated by Fire Code must be approved and permitted by the San Francisco Fire Department separately from this provisional permit.
- » Electric heaters may be used if applicant obtains an [electrical permit from the Department of Building Inspection](#) for an exterior mounted weatherproof electrical outlet. Proof of completed job card required.

S3 Diverters. The business must utilize pedestrian diverters on each side of the outdoor dining area to guide pedestrians around the business operations. The objects within the sidewalk space may not extend beyond the depth of the diverters at any time. The diverters must be:

- » At least 30 inches high (H), 12 inches wide (W), and 24 inches long (L)
- » Solid within at least 24 inches off the ground
- » Sturdy, stable, and heavy enough so they cannot tip over or be blown away by the wind
- » Distinctly visible to the visually impaired with contrasting colors.
- » Removable after business closure every day
- » Flush with the building at approximately 90 degrees
- » Free of advertising

S4 Accessible Route. Sidewalk Shared Spaces must maintain a continuous 8-foot minimum width pedestrian accessible route clear of obstructions at all times along the entire property frontage, including adjacent properties if applicable to their permit. Special conditions where an 8-foot path is not feasible will be reviewed on a case-by-case basis, and this exception requires approval from the Public Works Disability Access Coordinator during the permit review process.

The accessible route width is the width from any shared space element to the nearest obstruction (including existing utilities, signs, poles, tree wells, etc.), landscape area, curb, or other element that restricts pedestrian travel. The accessible route width shall in no case be less than 6 feet. Per the SF Better Streets plan, the accessible route should not meander and should be a straight path of travel for pedestrians to navigate easily along the entire block.

S5 Overhead Objects. Hanging or overhead objects, including umbrellas, must have a clearance of at least 7 feet (or 84 inches) from the ground. Clearance under awnings and canopies shall comply with San Francisco Building Code requirements.

S6 Trays and Carts. Food trays or carts, receptacles for dirty dishes, trays or carts for linen and utensils, and cooking appliances shall not be placed or stored on any portion of the sidewalk area.

S7 Bins. Trash, recycling, and compost bins shall be provided within the approved area, but always kept clear of all 3ft emergency access gaps. These bins can be kept inside the restaurant. All bins must be brought inside at end of business day.

S8 Sidewalk Modifications. No modifications may be made to the public sidewalk, including stickers or spray paint, other than social distancing markings. Any markings must be in accordance with [Public Works Order 203,240](#). No furniture may be fixed or bolted to the sidewalk.

S9 Accessible Furniture. Applicants must provide at least one (1) accessible table available for wheelchair users for each type of Shared Space. Accessible dining surfaces shall be dispersed throughout each shared space for each type of seating in a functional area, in accordance with CBC Chapter 11B. See Accessibility Supplement in this Section.

See full requirements at:
sf.gov/shared-spaces-accessibility

The curbside lane is the space on the road closest to the curb, often the parking lane. The curb has many uses and functions, serving the needs of a block and a neighborhood in different ways.

San Francisco has defined how these functions and users are prioritized in different land use contexts in The City's [Curb Management Strategy](#). These key curb functions are: access for people, access for goods, public space and services, storage for vehicles, and movement, including emergency access and public infrastructure operations.

Parking Lane Shared Spaces are mostly used for outdoor dining or retail, and typically involve the construction of a structure, commonly known as a parklet.

Decide what type of parklet you want to implement

TIER 1 Public Parklet: Similar to the City's pre-COVID parklets, a fixed structure providing full-time, publicly accessible space and no commercial activity.

TIER 2 Movable Commercial Parklet: A space occupied by the operator using movable fixtures during limited business hours with a bench or other public seating facility. Operators must choose up to 3 consecutive time blocks of the following available blocks: 8am to Noon, Noon to 3pm, 3pm to 6pm, and 6pm to 10pm.

TIER 3 Commercial Parklet: Similar to existing Shared Spaces, a fixed structure where an operator uses the parklet for commercial activity during business hours with a bench or other public seating facility, and is otherwise open to the public during non-commercial daytime hours, even when the operator's business is closed.

TIER	TYPE	PUBLIC ACCESS	COMMERCIAL ACTIVITY	DAILY OCCUPANCY	CONSTRUCTION
1	Public Parklet	Entire facility during daylight hours through 10pm	None	24/7	Fixed Structure
2	Movable Commercial Parklet	At least one bench during hours of commercial operation	8am to 12pm 12pm to 3pm 3pm to 6pm 6pm to 10pm	Up to 3 consecutive blocks from the available time block options	Movable Fixtures
3	Commercial Parklet	At least one bench during hours of commercial operation. Otherwise, entire facility during daylight hours through 10pm	During hours of operation	24/7 (operator may secure their parklet from 12am to 7am)	Fixed Structure

Where can I place my Shared Space?

P1 Length: You may apply for a **maximum of two** metered parking spaces, or 40 linear feet along the curb for parallel parking, or 20 linear feet along the curb for angled or perpendicular parking. Exceptions may be considered if all the other curbside functions are adequately accommodated on the block.

P2 Setbacks: All structures must maintain 3 feet setback from each end of the marked parking space for parallel parking spaces and 3 feet setback on each end for angled or perpendicular spaces. Exceptions may be considered for parking meter obstructions and red zones. All structures must maintain a setback of at least 2 feet from an active driveway or curb cut.

Parklet structures should be highly visible to other users of the road:

- » Minimum 20-foot clearance from approaching intersection (nearside). Curbside space near the intersection must be clear of any obstructions
- » Minimum 8ft clearance when exiting an intersection (farside).

P3 Width: You may occupy the full width of the parking lane (**7 feet max**) for parallel parking, and **14 feet max** for angled or perpendicular parking. *Exceptions may apply along rail, cable car, or other special cases that would necessitate reducing the width of the zone.

P4 Slope: The cross slope on the Parklet surface shall not exceed 2% in any direction. If proposed on a street grade greater than 5% additional design requirements and review may be required to make the space accessible to the maximum extent technically feasible as defined in the California Building Code.

Conflicts with existing city infrastructure



P5 A proposed location where there is a **bike-share station, bicycle rack, or bicycle corral** present will be considered and evaluated by City staff. If approved, the applicant will be responsible for modification, removal or relocation costs. The application will be put on hold until the conflict has been resolved. Applications may be denied if conditions are not met.



P6 Shared Spaces **may not be located in existing bicycle lanes**. Fixed structures may not be located in any location that would preclude the planned implementation of a bikeway within 12 months of the application submittal. Shared Spaces may be allowed in floating parking lanes, such as those next to 'parking-protected bike lanes,' on a case by case basis if City staff determine it to be safe and feasible; resulting zone must maintain an accessible path of travel.

P7 Color Curbs:

- » **Yellow Curb** (Commercial Loading), **Green Curb** (Short-term Parking), or **White Curb** (Passenger Loading Zone): City staff will evaluate if one of these color curb zones can be relocated on same block face to accommodate a proposed Shared Space. For passenger loading, if relocation will materially affect disabled access or no suitable replacement location can be identified, the application will be denied.
- » **Blue Curb** (ADA Accessible Parking Spaces): Shared Spaces may not be located in or impede access to blue accessible parking space. An 8' clearance from the curb to any shared space element is required for the entire length of a blue zone to allow for wheelchair lift deployment.
- » **Red Curb:** In most instances parklets are not permitted in red zones. City staff will consider these requests on a case-by-case basis



P8 Fixed structures may not be located in the following zones:

- » Peak or Commute Hour Tow-Away Lanes
- » Active Transit Zones
- » Transit Shelter
- » Flag Bus Stops
- » Transit Only Lanes
- » Temporary Emergency Lanes
- » Emergency (Red) Lane
- » Transit Maintenance Elements
- » Floating Parking Spaces

P9 Taxi Stands/Zones and Commuter Shuttle Stop:

City staff will evaluate the feasibility of removing, modifying or relocating these zones or stops. If a replacement location is found, the application will be put on hold until the relocated zone or stop is approved and relocated

P10 Shared Spaces may be restricted or must comply with additional design requirements where these transit zones or features are located:

- » Inactive Transit Zones
- » Overhead Wires
- » Muni Bus Routes
- » Muni Rail Lines: must be 5 feet away from any active Transit Zone and 6 feet away from the outer most edge of the rail
- » Muni Rail Stops: may be approved in suspended rail stops not currently serving active routes on a month-to-month basis
- » Cable Car Routes: will require a field visit prior to approval

How to design a Parking Lane Shared Space

If you're building a structure for your parklet, you must comply with the Design Guidelines and Regulations in this section. Your structure must be stable, sturdy, and safe for users and passers-by, retain emergency access, and be accessible for people with disabilities.

P11 A Parking Lane Shared Spaces structure or parklet shall not obstruct any underground and surface utility or stormwater facilities, including but not limited to: utility poles, gas valves, water valves, manhole covers, air release valves, sewer laterals, culverts, and catch basins.

All structures on parking lane must **allow for access to public utilities** for maintenance and repairs (e.g. provide access panels, removable pavers, modular design)



P12 Bolting: At no time should fixtures be bolted or affixed in any way to the roadway or any structure (including but not limited to: buildings, fire hydrants, street trees, streetlight or traffic poles, etc.)

P13 Concrete: Pouring concrete for Shared Spaces platforms is not allowed. You may use concrete pavers on a platform structure instead.

P14 Surface materials. Loose particles, such as sand or loose stone, are not permitted on the parklet. Platform surface materials must be textured or treated with a slip resistant coating to ensure a safe walking surface.

P15 Drainage: Platforms should **allow for curbside drainage flow**. A 6 inch x 6 inch minimum clear gutter space must be provided along the entire length of the proposed platform.

P16 Overhead objects: Hanging or overhead objects, including umbrellas, must have a clearance of at least 7 feet (or 84 inches), and cannot exceed 10 feet (including poles, posts, canopies, wires, signs) from the ground. Clearance under awnings and canopies shall comply with San Francisco Building Code requirements.

P17 Bins: Trash, recycling, and compost bins should be provided within the approved area, if space allows. These bins can be kept inside the restaurant.

P18 Roadway Modification: No modification may be made to the public roadway, including stickers or spray paint, other than social distancing markings. Any markings must be in accordance with Public Works regulations.

Emergency Access

Emergency responders utilize the most direct path to access a building from the street to assist citizens in need of medical attention or for firefighting operations. Obstructing emergency access may lead to immediate danger to health or life safety. The following safety guidelines are required:

- P19** A minimum 3-foot-wide emergency access gap, with vertical and horizontal clearance, is required for every 20 feet of structure length. This 3-foot access must be maintained clear of any obstacles (tables, chairs, bike racks, trees, poles, or other elements like gates) at all times, including outside of business hours.
- P20** A removable, rigid barrier is required at the 3-foot gaps. The barrier must be easily removable by emergency personnel at all times.
- P21** At no time can parking lane occupancy obstruct emergency facilities (including, but not limited to fire hydrants, red zones, fire department connections, fire escapes, etc.).
- P22** The sidewalk space between the curb and the building and each 3-foot-wide emergency access opening shall remain clear of overhead obstructions (string lights, canopies, decorations, heaters, wires, trees, poles, etc.) at all times, as ladders and other emergency equipment may need to be carried through the opening to the building.
- P23** No fixed obstructions to the view of the adjacent building above 42 inches other than a roof or canopy at a minimum of 8 feet.
- P24** No canopies/roofs on parklets shall be permitted when sidewalk is less than 10 feet wide.
- P25** No part of the parklet structure shall extend over the curb or sidewalk
- P26** No part of the structure shall exceed 10 feet in height, (including poles, posts, canopies, wires, string lights, signs, or pergolas) while still complying with the maximum 42 inch high enclosure construction requirements above. If building a structure where Muni overhead lines are present, the top of the structure (including any roof) must not be taller than 9 feet above the road surface.
- P27** Trees shall be maintained and trimmed to keep away from building, fire escape, and parklet roof/canopy. No tree shall be pruned without consent from Bureau of Urban Forestry. See *Page 104* for more details.
- P28** Overhead fixed lighting or heater cords to fixed Parklets from buildings shall be plugged into a weatherproof electrical outlet installed on the exterior of the building at a minimum of 10 feet above the walking surface. No fixed cables/wires/conduit shall be used to support the light's cord and it shall be able to be easily unplugged by fire department personnel. Power cords between the building and parklet shall be limited to one (1) cord at each end of entire parklet space and shall not be adjacent, above, below or attached to any part of the fire escape. These "flyover" cords shall be limited to standard cords plugged directly into an electrical outlet. No extension cords shall be permitted for fixed lighting or heaters. Cable ramps are not permitted. Installation of weatherproof electrical boxes at your building require a DBI permit and inspection for approval.
- P29** All cables, cords, or wires used for lighting and speakers shall be run overhead. Cable ramps are not permitted. Portable Battery-Powered generators located within the shared space may be used.
- P30** Electric heaters may be used if applicant obtains an electrical permit from the [Department of Building Inspection](#) to install exterior electrical outlets at their building.

P29 Overhead cables, cords, or wires



P31 The address for each storefront or building where the outdoor dining area will be established shall be displayed at a height of 36 to 42 inches on the street-facing side of the barriers and be readily visible for emergency responders. Address numbers shall be a minimum of 4 inches tall (5/8-inch-wide stroke) with black numbers on a white background or other high-contrasting colors.

P32 “NO PARKING - SFFD ACCESS - KEEP CLEAR AT ALL TIMES” signs shall be added to ends of parklet to keep motorcycles or bicycles from parking within the 3-foot end fire access gaps. Find signage specifications in *Section 3: Shared Spaces Operations*.

Fire Safety

P33 The use of propane (LPG) is regulated by the Fire Department. A separate SFFD Operational Permit is required for storage and use of liquid propane gas (San Francisco Fire Code 105.6.27) for Shared Spaces. Please go to www.sf-fire.org/permits or **628-652-3260** for more information.

P34 Roofs and canopies are discouraged, but if installed, propane heaters cannot be placed underneath overhead canopies, awnings, inside buildings or tents and they must have 5-foot clearance from any flammable materials. A LPG permit will not be issued if roofs or canopies are constructed over the Shared Space.

P35 A site plan with the desired location of each heater is required at time of SFFD permit application. A final on-site SFFD permit inspection will be conducted to ensure the proper spacing of heaters from combustibles and emergency access/egress.

P36 Use outdoor heating fixtures safely and according to State and City Code Requirements.

P37 Propane (LPG) is flammable and can be readily ignited by a spark. If confined or exposed to fire, propane poses an explosion hazard. Propane is heavier than air, which means it accumulates in low places, where people and ignition sources exist.

P38 On-site storage of 20-pound propane containers (5 gals.) is prohibited indoors.

P39 Proposed outdoor storage of 20-pound propane containers requires plan review and inspection by SFFD. Propane (LPG) storage is not allowed in the public right-of-way, per Public Works.

P40 If businesses do not have an approved private outdoor storage area, all propane containers must be removed from the premises at the close of business every day.

P41 If natural gas heaters are to be used, the gas piping shall be installed below the walking surface in the sidewalk. Additional permits required.

Accessibility

You must take the appropriate actions to be accessible and safe.

The proposed structure shall be designed, constructed and/or conform to the applicable provisions, rules, regulations and guidelines of the: San Francisco Building Code (SFBC) and Americans with Disabilities Act 2010 Standards accessibility requirements (ADAS). All structures must also [follow our accessibility rules](#) to use the parking lane for your business. See full requirements at: sf.gov/shared-spaces-accessibility

P42 The business must provide 5% but not less than one (1) accessible table available for wheelchair users. Accessible dining surfaces shall be dispersed throughout each shared space for each type of seating in a functional area, in accordance with CBC Chapter 11B. See Accessibility Supplement in *Appendices Subsection 9* for details

P43 Temporary ramps in the Public Right-of-Way, if required to provide accessibility to a parking lane space, shall comply with the slope requirements detailed in *Appendices Subsection 9*.

P44 If you apply for a Shared Spaces permit on a street that **exceeds a 5% grade**, you will receive additional accessibility information with your permit.

P45 Platform threshold. The deck of the parklet platform shall be flush with the sidewalk without a horizontal or vertical separation greater than 1/2 inch. Vertical separations between 1/4 inch and 1/2 inch high shall be beveled with a slope not steeper than 1:4 (25%).

P46 Accessible Deck Surface: The portion of the parklet deck connected by the accessible path of travel to the wheelchair turning space and wheelchair resting space must be level. The accessible deck surface maximum cross slope (perpendicular to the sidewalk or curb) cannot exceed 1:48 (2%). The accessible deck surface maximum running slope (parallel to the curb) cannot exceed 1:20 ($\leq 5\%$). Accessible floor and ground surfaces must be stable, firm, and slip

resistant.

P47 Accessible Entrance: minimum 48 inches wide. All entrances are required to be flush with the sidewalk and accessible per the California Building Code, Chapter 11B. Vertical elevation differences above 1/2 inches require an accessible ramp (1:12 max slope)

P48 Accessible Route: It must connect the sidewalk through the accessible entrance, to the deck surface, wheelchair turning space and wheelchair seating area.

P49 Wheelchair Turning Space: Shall be 60 inches in diameter and located entirely within the platform; a 12- inch maximum overlap on the curb and sidewalk is acceptable. A T-turn per California Building Code 11B is also acceptable.

P51 Accessible Facilities. Where tables, counters, or drink rails are provided, at least one of each feature shall be wheelchair accessible.

The top surface height of wheelchair accessible tables, counters and or drink rails shall be 28 inches to 34 inches above the Deck Surface. Wheelchair accessible tables and counters shall be approachable from the front and provide an unobstructed knee clearance that is at least 27 inches high, 30 inches wide and 19 inches deep. When movable tables are provided in lieu of fixed, at least one of the movable tables must also be accessible. The accessible counter portion shall be 60" minimum in length.

Where drink rails are provided, a 60 inch long portion of a drink rail shall have 36 inch wide and level space adjacent to it for a side-approach by a wheelchair user.

P52 Terraced or Multi-Level A. For parklets proposed on streets with grades that exceed 5%, a terraced parklet with two or more habitable decks is acceptable. Typically, each of these terraces must be wheelchair accessible. In some cases, due to existing constraints it may be infeasible to provide an accessible route to each terrace. An exception may be approved on a case by case basis by the Public Works Disability Access Coordinator.

The accessible terrace will require a wheelchair accessible entrance from the sidewalk. The wheelchair accessible entry may be achieved with a structure on the sidewalk within the sidewalk furnishing zone that provides transition between the sidewalk and parklet deck.

Passage between terrace levels may be achieved with a ramp with a running slope not to exceed (1:20) 5%; steps or stairs where a ramp is not practicable. Any step or stair will require a warning strip at the nose of the step and handrails per California Building Code.



Structural Integrity

The proposed structure and its components (platform, walls, and roof) shall be built with structural integrity to ensure public safety. The proposed structure and its components are built to support anticipated live loads and wind loads. Alternate designs may be submitted for review and approval. Such drawings and calculations shall be stamped and signed by a design professional registered in the State of California. These guidelines are intended to provide guidance for the structural integrity of shared spaces structures, but are not intended to provide or ensure safety from vehicular traffic.

P53 You should use **durable materials** that can withstand wear and tear of elements. It's your responsibility to maintain all structural elements in good condition. Proposed materials shall comply with Public Works Slip Resistance Requirements to ensure a safe and accessible walking surface. Loose particles, such as sand or loose stone, are not permitted.

P54 The platform framing shall be a freestanding structural foundation that rests on the street roadway surface. **No features or structural components may be permanently attached** to the street roadway, gutter, curb, planting area, or sidewalk.

P55 Platform framing shall be supported on pressure treated lumber or pedestals.

P56 Platform surface shall be minimum 1x wood decking boards or 3/4" plywood sheathing secured to the framing below. Pavers or other materials may be applied over plywood sheathing.

P57 Platform framing shall be minimum 2x4 floor joists spaced at maximum 24" apart and supported at maximum 3 feet intervals. Provide solid blocking between joists at support locations.

P58 Floor joists shall be secured with appropriate framing angles.

P59 Finished platform surface shall be flat with a maximum slope of 2%.

P60 All framing elements shall be adequately fastened consistent with the standards in "[Details for Conventional Wood Frame Construction](#)" (2001) published by the American Wood Council

P61 Proposed platforms on streets steeper than 5% longitudinal (running) slope shall be designed and stamped by a design professional registered in the State of California. The design professional shall ensure compliance with San Francisco Building Code (SFBC) and Americans with Disabilities Act 2010 Standards accessibility requirements (ADAS).

Walls

P62 Your enclosure must be stable and sturdy enough not to fall over or be pushed over. If you're building a platform as part of your structure, all walls and enclosure structures must be secured to the platform for structural stability.

P63 A continuous rigid physical separation is required to separate Shared Spaces areas on the parking lane from vehicular traffic on all three sides open to the roadway. The traffic barriers must meet the following requirements:

- » Have a railing height of 42 inches (measured from the deck surface to the top of the wall surface) with openings of no more than 3.5 inches.
- » Have a rigid rail with a solid rail at the top and a solid rail at the bottom. The height to the top of bottom rail shall not be less than 6 inches above the deck. The gap under the bottom of the rail shall not exceed 3.5 inches.
- » Perimeter walls shall be fastened to the platform with 1/4" diameter x 3" wood screws spaced at maximum 12" apart. 2x studs shall be fastened to sill plate with Simpson A35 framing angles, or equivalent.
- » Shall resist a single concentrated load of 200 pounds applied in any direction at 42 inches above top of platform surface. In addition, the wall shall resist a load of 50 pounds per linear foot applied in any direction at 42 inches above top of platform surface.

- » Perimeter partial height walls shall be sheathed with minimum 1x6 sheathing or ½” plywood. 1x sheathing may be spaced with gaps less than 4” wide.
- » A water-filled “Jersey Barrier” may be used. Orange color is recommended for better visibility.

P64 If you wish to install panels above 42 inches to separate tables or act as wind barriers, you will have to use transparent sheathing such as polycarbonate sheets and shall be adequately fastened to wall framing.

P65 You will need to comply with Accessibility Guidelines for Furniture. See *Subsection 9: Accessibility Supplement* for more information.

P66 Any internal partitions shall be perceptible and physically discernible by people who are blind and/or low vision. Internal partitions require a 42-inch-high rigid frame that is a 4-inch-thick minimum frame around the entire opening.



Photo by Shared Spaces

Roof Structures

P67 Roof canopies may be constructed with plywood sheathing, polycarbonate sheets, or sheet metal, and sloped to drain towards the street and away from the sidewalk.

P68 Plywood roof sheathing shall be minimum 3/8” thick sheathing and secured to roof framing with minimum 8d nails at 6” spacing at all framing.

P69 Corrugate polycarbonate sheets shall be minimum 0.032” thickness and secured to roof framing with minimum #10 x 2” self-drilling/ tapping wood screws at crown of every other corrugation. Sheets shall be supported on purlins at maximum 24” spacing. Overlap adjacent corrugated sheets and provide infill closure strips between sheet and framing at ends.

P70 Multi-layered polycarbonate sheets shall be minimum 5/16” thickness.

P71 Roof joists shall be minimum 2x4 spaced maximum of 24 inches apart and spanning to beams spaced at maximum 8 feet apart. Beams that support rafters shall be minimum (2)-2x6 or 2x8 and shall be supported by minimum 4x4 posts spaced at maximum 10 feet apart. Elevation of top of roof assembly shall be 8 feet minimum and 10 feet maximum above sidewalk grade.

P72 No tree shall be pruned without consent from Bureau of Urban Forestry (BUF). If your structure is adjacent to a street tree, a Shared Spaces operator is responsible for hiring a certified Arborist to prune trees at their cost, due to impacted BUF operations.

P73 Tree basins must be backfilled to grade

P74 Tree damage from parklet construction will result in a minimum \$2,230 fine.

P75 Shared Spaces operators must agree to provide water to newly planted trees adjacent to their permitted space whenever Bureau of Urban Forestry is not able to access them.

Traffic Safety

P76 The **enclosure should not block** the view of traffic, including pedestrian traffic, nor block the view of traffic control devices such as traffic signs, traffic signals, and other traffic warning devices. It should not obstruct motorists' visibility of traffic signals from 200 feet away (about half a block).

P77 You must mark the edges or corners of your enclosure with yellow **high intensity retro-reflective tape** or reflectors to be visible to drivers at night.

P78 Flexible Delineator Posts: Purchase four standardized flexible delineator posts, two for each end of the parklet. You may purchase the posts from any vendor, but they must meet these specifications:

- » Safe Hit Type 2 Guide Post
- » 36 inches tall, white
- » Surface Mount Pin Lock Base
- » Butyl Adhesive Pad or 10 oz. Epoxy Kit

P79 Wheel Stops: You may purchase these from any vendor, but they must meet these specifications:

- » 3 feet long
- » Black rubber with yellow stripes
- » Mounted with bolts
- » Installed three feet from outside ends of Parklet which occupies parallel parking spaces. The City will advise you on placement for parklets in diagonal or perpendicular parking spaces
- » Installed 12 inches from the curb

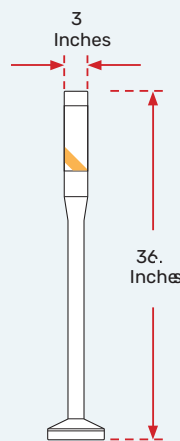

9. Accessibility Supplement

The City and County of San Francisco seeks to make its public realm accessible to and usable by individuals with disabilities. This goal extends to the Shared Spaces program, which become an extension of public sidewalks and pedestrian open space. All accessibility elements of the proposed Shared Space shall be designed, constructed and/or conform to the applicable provisions, rules, regulations and guidelines of the: San Francisco Building Code (SFBC), Americans with Disabilities Act 2010

Standard’s accessibility requirements (ADAS), and other design criteria included in Public Works Order No. 183,392 for Temporary Sidewalk Extensions (Parklets). The required standards and guidelines on the following pages are intended to supplement and expand upon the accessibility requirements in this Manual.

Accessibility for Furniture

- Applicants must provide 5% but not less than one (1) accessible table available for wheelchair users, meeting the following requirements:
- Be between 28 to 34 inches high.
- Have at least 27 inches of space from the floor to the bottom of the table.
- Provide knee clearance that extends at least 19 inches under the table.
- Have a total clear floor space of 30 inches by 48 inches per seat.
- Be located a minimum distance of 4 feet to the nearest obstruction.
- Have a label displaying the International Symbol of Accessibility.
- Maintain an accessible route to the table. For Shared Spaces in the parking lane, providing an accessible ramp is required if there’s no platform flush with the sidewalk.
- Tables and chairs on sidewalks with a greater than 5% slope may be subject to additional staff review or operational requirements.
- Accessible dining surfaces shall be dispersed throughout each shared space for each type of seating in a functional area, in accordance with CBC Chapter 11B.

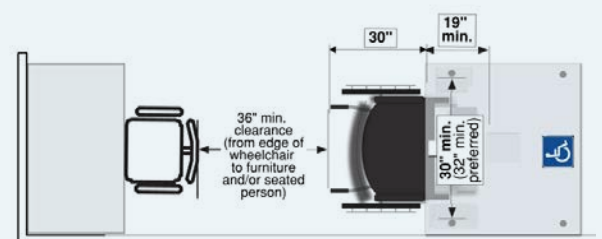
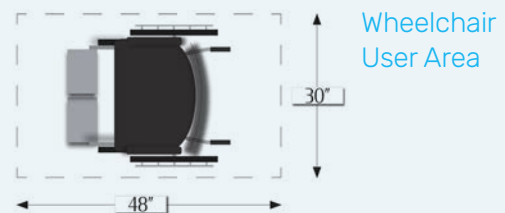
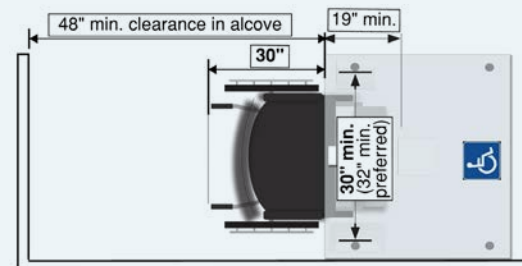
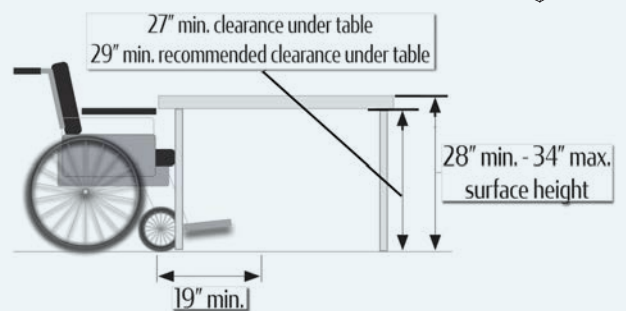
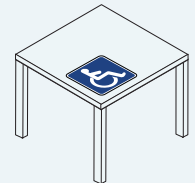

- Temporary ramps in the Public Right-of-Way, if required to provide accessibility to a parking lane space, shall comply with the requirements in the California Building Code, Chapter 11B which are summarized as follows:
 - » 4-foot minimum clear ramp width.
 - » 8.3% (1:12) maximum ramp running slope (slope parallel to direction of travel).
 - » Clear landing at top and bottom of the ramp (4-foot x 4-foot minimum).
 - » Unobstructed accessible route from the pedestrian throughway path of travel of the sidewalk to the ramp.
 - » Edge protection is required on each side of the ramp. A curb or barrier shall be provided that prevents the passage of a 4-inch diameter sphere or side flares that do not exceed 10% slope (1:10). To prevent wheel entrapment, the curb or barrier shall provide a continuous and uninterrupted barrier along the length of the ramp.
 - » Ramp shall be firm, stable and slip resistant. The ramp must be securely attached so it does not move or shift during use.

Compliant Ramps

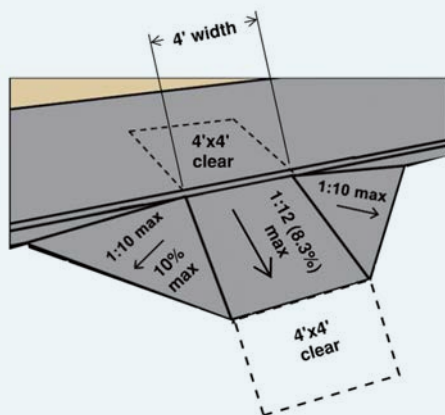

This page left intentionally blank

10. Public Health

Alcoholic Beverage Control

The current ABC temporary permits are valid until the end of the year, when the emergency regulations expire. Pending legislation would allow ABC to extend these permits for another year, or for longer where an applicant has applied to permanently expand their premises to include the outdoor area currently covered by the temporary permit. Visit [California Department of Alcoholic Beverage Control](#) for details and updates.



San Francisco
**Shared
Spaces**

sf.gov/sharedspaces